

**VITRO<sup>®</sup>**  
SEATING PRODUCTS

# 2026 PRICE LIST

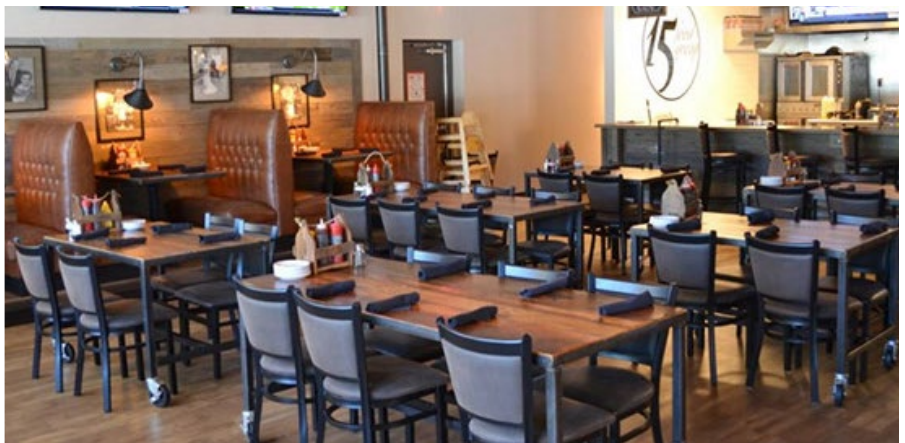

# Table Of Contents

## Chairs & Stools

### Innovations

INN - 2100.....	15
INN - 2110 BS.....	15
600 - INN - 2120 BS.....	15
1800 - INN - 2120 BS.....	15
INN - 2200.....	16
INN - 2210 BS.....	16
600 - INN - 2220 BS.....	16
1800 - INN - 2220 BS.....	16
INN - 2300.....	17
INN - 2310 BS.....	17
600 - INN - 2320 BS.....	17
1800 - INN - 2320 BS.....	17
INN - 2400.....	18
INN - 2410 BS.....	18
600 - INN - 2420 BS.....	18
1800 - INN - 2420 BS.....	18
INN - 2500.....	19
INN - 2510 BS.....	19
600 - INN - 2520 BS.....	19
1800 - INN - 2520 BS.....	19
INN - 2600.....	20
INN - 2610 BS.....	20
600 - INN - 2620 BS.....	20
1800 - INN - 2620 BS.....	20

### Cafe

MAN - 200.....	21
PLM - 100.....	21
PLM - 1100 BS.....	21
HPN - 100.....	22
HPN - 1100 BS.....	22
MAD - 100.....	23
MAD - 1100 BS.....	23
MKT - 100.....	23
MKT - 1100 BS.....	23
TUK - 100.....	24
TUK - 1100 BS.....	24
TUK - 1150 BS.....	24
BRD - 1000 BS.....	26
BRD - 1100 BS.....	26
DM-100.....	27
DM-200.....	27
DM-1100 BS.....	27
DM-1200 BS.....	27

### Manhattan

MAN - 1100 BS.....	28
MAN - 140.....	28
MAN - 1160 BS.....	28
MAN - 1220 BS.....	30
MAN - 250 PS4.....	30
MAN - 250 PS3.....	30
MAN - 1250 BS.....	31
MAN - 300 FP.....	31

### Woodland

WLS - 100.....	32
WLS - 1000 BS.....	32
WLS - 180.....	32
WLS - 1180 BS.....	32
WLS - 200.....	33
WLS - 1200 BS.....	33
WLS - 300.....	34
WLS - 1300 BS.....	34
WLS - 1310 BS.....	34
WLS - 582.....	35
WLS - 1582 BS.....	35
WLS - 568.....	35
WLS - 1568 BS.....	35

### Legends

LSC - 250.....	39
LSC - 1250 BS.....	39
600 - LSC - 250 BS.....	39
1800 - LSC - 250 BS.....	39
LSC - 350.....	40
LSC - 1350 BS.....	40
600 - LSC - 350 BS.....	40
1800 - LSC - 350 BS.....	40
LSC - 450.....	41
LSC - 1450 BS.....	41
600 - LSC - 450 BS.....	41
1800 - LSC - 450 BS.....	41
LSC - 475.....	42
LSC - 1475 BS.....	42
600 - LSC - 475 BS.....	42
1800 - LSC - 475 BS.....	42
LSC - 501.....	43

LSC - 1501 BS.....	43
600 - LSC - 501 BS.....	43
1800 - LSC - 501 BS.....	43
LSC - 550.....	44
LSC - 1550 BS.....	44
600 - LSC - 550 BS.....	44
1800 - LSC - 550 BS.....	44
LSC - 575.....	45
LSC - 1575 BS.....	45
600 - LSC - 575 BS.....	45
1800 - LSC - 575 BS.....	45
LSC - 600.....	46
LSC - 1600 BS.....	46
600 - LSC - 600 BS.....	46
1800 - LSC - 600 BS.....	46
LSC - 650.....	47
LSC - 1650 BS.....	47
600 - LSC - 650 BS.....	47
1800 - LSC - 650 BS.....	47
LSC - 750.....	48
LSC - 1750 BS.....	48
600 - LSC - 750 BS.....	48
1800 - LSC - 750 BS.....	48

### Oxford

OX - 10.....	49
OX - 110 BS.....	49
600 - OX - 10 BS.....	49
1800 - OX - 10 BS.....	49
OX - 20.....	50
OX - 120 BS.....	50
600 - OX - 20 BS.....	50
1800 - OX - 20 BS.....	50
OX - 30.....	51
OX - 130 BS.....	51
600 - OX - 30 BS.....	51
1800 - OX - 30 BS.....	51
OX - 40.....	52
OX - 140 BS.....	52
600 - OX - 40 BS.....	52
1800 - OX - 40 BS.....	52
OX - 50.....	53
OX - 150 BS.....	53
600 - OX - 50 BS.....	53
1800 - OX - 50 BS.....	53
OX - 60.....	54
OX - 160 BS.....	54
600 - OX - 60 BS.....	54
1800 - OX - 60 BS.....	54

## 1800 Series Wood Stools

1800 Series Stool Bases.....	55
------------------------------	----

## Omni & Spectrum

SCB - PS.....	56
CBBS - PS.....	56
DS - PS.....	56
DSBS - PS.....	56
FB - PS.....	57
SFB - BS.....	57
FBBS - PS.....	57
HG - PS.....	57
HGBS - PS.....	58
HP - PS.....	58
HPBS - PS.....	58
IT - PS.....	58
ITBS - PS.....	59
MR - BS.....	59
SMR - PS.....	59
MRBS - PS.....	59
PB - PS.....	60
PBBS - PS.....	60
RB - PS.....	60
RBBS - PS.....	60
SSB - PS.....	61
SBBS - PS.....	61
UFB - PS.....	61
UFBBS - PS.....	61
UHP - PS.....	62
UHPBS - PS.....	62
USB - PS.....	62
USBBS - PS.....	62
BLBS - PS.....	63

## Stacker Chair

RO - 150 SH.....	64
RO - 200 WF.....	64
X - 6.....	64
X - 10.....	64
X - 18.....	65
X - 18 LS.....	65
X - 18 LSIB.....	65
Extra Chair Features.....	65
X - 23.....	66
X - 23 AR.....	66
X - 24 Econo.....	66
Chair Dolly.....	66

Chair Caddy.....	66
X - 25.....	67
X - 25 WF.....	67
X - 25 ISDT.....	67
X - 25 WFCB.....	67
X - 37.....	68
X - 37 LS.....	68
X - 37 WF.....	68
X - 37 ISCB.....	68
X - 38.....	69
X - 38 LS.....	69
X - 38 WF.....	69
X - 38 LSDT.....	69
X - 43.....	70
X - 43 WF.....	70
X - 43 WFHR.....	70
X - 45.....	71
X - 45 LS.....	71
X - 45 SH.....	71
X - 45 WFCB.....	71

## School

907 - 242 WF.....	72
S - 3 Tilting.....	72
S - 4 Non-Tilting.....	72

## Parlor

X - 52.....	73
X - 52 BS.....	73
X - 53.....	73
X - 53 BS.....	73
X - 54.....	74
X - 54 BS.....	74
X - 56.....	74
X - 55 BS.....	74

## Classic Chairs & Stools

921.....	75
921 "V".....	75
921 DT.....	75
921 BS.....	75
921 ELSH.....	76
921 ELSH - BS.....	76
921 MBWF.....	76
921 MBWF - BS.....	76
921 HB.....	77
921 HB - BS.....	77
921 HBSH.....	77

921 HBWF - BS.....	77
921 HBMBSH.....	78
921 HBMBWF - BS.....	78
921 BB.....	78
934.....	78
939 CBWF.....	79

## Classic Stools

215 - 46.....	80
215 - 125 R.....	80
215 - 125 RB.....	80
215 - 530.....	80
215 - 531 SH.....	81
215 - 782/49 NS.....	81
215 - 782 RB/49 NSRB.....	81
215 - 921.....	81
250 - 49 NS.....	82
250 - 49 NSRB.....	82
250 - 781/46.....	82
250 - 782.....	82
250 - 782 RB.....	83
250 - 921 BB.....	83
250 - 921 MB.....	83
250 - 921 "V".....	83
264 - 49 NSRB.....	84
264 - 125.....	84
264 - 161.....	84
264 - 530.....	84
264 - 781/46.....	85
264 - 782/49 NS.....	85
264 - 782 RB.....	85
264 - 921.....	85
265 - 125 R.....	86
265 - 125 RB.....	86
265 - 242 WF.....	86
265 - X23.....	87
751 Econo.....	87
752 Econo.....	87
300 - 49 NS/782.....	88
300 - 49 NSRB/782 RB.....	88
300 - 161.....	88
300 - 531 SH.....	88
300 - 781/46.....	89
300 - 921/530.....	89
300 - 921 "V".....	89
300 - 939 CB.....	89
400 - 49 NS.....	90



UWB - 175.....	149
UWR - 175.....	149
SW-150.....	150
SW - 125.....	150
CW - 125.....	151
BGA - 125.....	152
BGA - 125 Vitro Gloss Cracked Ice	153
BGA - 125 Vitro Gloss Boomerang	154
BGA - 225.....	155
BGA - 225 Vitro Gloss Cracked Ice	156
BGA - 225 Vitro Gloss Boomerang	157
SE - 125.....	158
SE - 200.....	159

## Table Bases

Bases.....	160
“A” series.....	161
“B” series.....	162-163
“C” series.....	164-166
“D” series.....	167-168
Flip - Top.....	169
“F” series cantilever.....	170
“G” series cantilever.....	170
“H” series.....	172
“H” Teardrop series.....	172
1800 TB Series.....	172
PL-1 Pin Leg.....	173
884 Legs.....	173
885 Legs.....	173

## Accessories

Hall Costumer.....	173
Booth Costumer.....	173
Acrylic Booth Divider.....	173

## What Makes Vitro Seating Products Different?

The majority of furniture Vitro provides is produced and manufactured here at our facility in St. Louis, Missouri. Our six story factory is constantly working to help your business thrive.

# Information

## General Information, Terms & Conditions

This price list is effective and supersedes all Vitro Seating Products previous price lists. Possession of this list does not constitute an offer to sell merchandise listed herein. All prices are subject to change without notice and are FOB St. Louis, Missouri factory.

## Terms

All orders are subject to credit approval. Open account terms are net 30 days and a service charge of **1.5%** per month will be added to delinquent invoices. Buyer shall be liable for all collection costs, attorneys' fees and court costs. Visa, Mastercard, and American Express cards are accepted with a 3% processing fee.

## Initial Orders

Initial orders require a **50% deposit** with the balance due before shipment. All new accounts should also forward a credit application, including bank references, and 5 trade references, with the purchase order. Vitro reserves the right to alter or cancel credit terms at its discretion, and request payment in advance.

## Quotations

All written quotations received from Vitro are valid for a period not to exceed **30 days**, unless extended in writing from the factory. Quoted delivery dates are estimated and subject to change due to unanticipated volume or other events beyond the control of Vitro, such as delays in receipt of materials or parts, etc. Any prices or freight quotations received from Vitro must accompany, or be included on the purchase order.

## Basic Ordering Information

To insure your order is correctly processed, please see order information page. Incorrect and incomplete orders produce production delays and can be very expensive. Again, please be very thorough and accurate.

## Fax and Email Orders

Purchase orders must be submitted via FAX (**800.476.2258**) or email (**Order@vitroseating.com**), which is encouraged to improve lead time. However, it is extremely important to follow up with the original purchase order clearly marked "confirmation, do not duplicate," in the event transmission of the FAX or email was improper or not received.

**Minimum order fee:** Orders under \$250.00 will carry a \$35.00 processing fee.

## Order Acknowledgments

All orders accepted by Vitro Seating Products will be acknowledged in writing to the buyer. **The buyer is responsible for checking this acknowledgment** to insure that all information is correct, with respect to quantity, pricing, finish, style, upholstery, shipping information, etc. **Unless Vitro is notified within 5 days of any discrepancy or error on our order acknowledgment, Vitro assumes no responsibility for manufacturing other than in accordance with the acknowledgment.** If our acknowledgment is not received within 1 week from the date of order, please advise Vitro immediately, as the order may have not been received.

## Ordering Information

To insure that your order is correctly processed and scheduled, please be thorough and accurate by listing the following information:

**Purchase Order Including:**

1. Your company's name, address, telephone # and account #
2. Your company's contact name and extension #
3. The "SHIP TO" address and contact name
4. Specify truckline (*Or indicate Vitro to route*)
5. Specify "collect" or "third party" billing - Prepaid by Vitro

**Chairs:**

1. Model #
2. Upholstery *\*(Grade, manufacturer, pattern & color)*
3. Frame finish (*Note: all finishes are not available on all items*)
4. Quantity - priced accordingly
5. Non - standard details should be described appropriately

*\* Should you choose upholstery other than those illustrated on our upholstery card, a factory quote is required prior to your order. Should you desire to supply us with COM (Customer's Own Material), it should be sent to us according to instructions supplied on the following page. Please provide us with the name of the manufacturer, their pattern # and color # - if they are not a common manufacturer, please give us their address and telephone number.*

**Stools:**

1. Model #
2. Seat Ht. (*Some models not available in hts. other than 30"*)
3. Upholstery *\*(Grade, manufacturer, pattern & color)*
4. Frame finish (*Note: all finishes are not available on all items*)
5. Quantity - priced accordingly
6. Floor attachment where applicable
7. Non - standard details should be described appropriately

*\* Should you choose upholstery other than those illustrated on our upholstery card, a factory quote is required prior to your order. Should you desire to supply us with COM (Customer's Own Material), it should be sent to us according to instructions supplied on the following page. Please provide us with the name of the manufacturer, their pattern # and color # - if they are not a common manufacturer, please give us their address and telephone number.*

**Table Tops:**

1. Model #
2. Top size
3. Laminate selection - MFG, Number, Color, and Name
4. Edge color and style
5. Quantity - priced accordingly
6. Other details - such as radius corners, diagonal cuts, wood finish, etc.

**Table Bases:**

1. Model # (*Includes series and size*)
2. Finish (*Painted or plated*)
3. Quantity - priced accordingly
4. Other details - such as self - leveling glides, bar height, etc.

**Booth Seating:**

1. Model name and model #
2. Upholstery description - illustrate if detailed (*MFG, Pattern, Name, Color #*)
3. Quantity of each style (*Single, double, etc*)
4. Height and length (*36" ht - 44" length is generally standard*)
5. Other details such as laminate or wood trim (*See below*)

*It is extremely important to provide as much detailed information as possible when ordering booths. It is helpful, and often necessary, to provide us (Even prior to your order for quotation) with a ¼" scale layout of the restaurant, along with field dimensions for wallbenches and circles. In addition, should the booth appearance be detailed, you should supply us with an illustration explaining those details.*

**COM Procedures (Customer's Own Material):**

1. All orders must have a 6" X 6" sample of COM submitted
2. COM priced grade 1
3. Material that is directional or striped, must specify the details concerning how it is to be applied, etc - you should increase the yardage requirements by 20% for best matching and repeat, or for a more accurate estimation of yardage, submit a sizeable sample to our factory for quotation, add 15% to the grade 1 price of the product for items upholstered with COM that require directional attention and/or difficulty in application (*Perhaps due to non - stretch or railroading, etc.*)
4. If material is or can be reversible, be certain to mark the proper side.
5. Supply your shipper of the COM with the following tag to be attached to the outside of the package containing your COM.

**COM (Customer's Own Material) Note**

All COM pricing is grade 1 and it is based on 54" wide plain, solid color vinyl or textile and should be clearly identified on package exterior. Repeats, grain directions, and patterned material require grade increase. Details such as direction, pattern repeat, and large swatches must be submitted to the factory to determine pricing.



**COM TAG**

Yardage Shipped: \_\_\_\_\_

Pattern ID: \_\_\_\_\_

Color ID: \_\_\_\_\_

Customer Name: \_\_\_\_\_

Customer PO#: \_\_\_\_\_

**Please photocopy this tag to accompany your COM**

*Vitro reserves the right to refuse any COM and accepts no responsibility for the warranty or tailoring quality of COM*

### Order Changes & Cancellations

Due to the custom nature of our products, Vitro must specify purchase materials and individually assemble to meet the unique and demanding specifications designated in each purchase order. Therefore, once Vitro accepts and acknowledges an order, it is fully binding and is not subject to cancellation or change by the buyer.

This does not mean that it is never possible to cancel or change an order, however, the request must be in writing, approved and acknowledged by the factory and may require charges for labor, materials, and/or other expenses we have incurred. Order will in some cases require updated ship date.

### Previous Order Matching

If your order is to match a previous order, it must be clearly stated on your order, with reference made to our original invoice or acknowledgment number and date. **If available, please supply a copy of the original invoice.** Vitro is not responsible to supply materials such as laminate, vinyl, fabrics or other items that may be discontinued.

Finishes (*Fabrics, vinyl, stains, and paints*) may change over a period of time and it is recommended that the buyer submit a sample from the original order when possible to assure the best possible match. When a special wood finish is requested, Vitro will attempt to match as closely as possible, but cannot assume responsibility for variations resulting from application of color finishes on various woods. Vitro in some instances may request the buyer return a signed approval prior to production.

### Discontinued Styles

Often a number of styles from previous price lists or catalogs are discontinued or retired from the line and no longer listed in the catalog or price list. **This does not always mean that these items are no longer available**, but may have been discontinued and replaced with a similar item or may still be available upon request. Please feel free to call our customer service department for information on these particular items.

## Shipping

All prices in this price list are FOB Factory St. Louis, Missouri 63102.

Buyers should advise preferred shipping and routing with each order. If no carrier is requested by name, or if named carrier does not serve our factory or consignee location, Vitro will ship by the method deemed most practical, but will not be responsible for any differences in freight charges.

All ship dates quoted are approximate. Any orders shipped later than the factory scheduled ship date are free from any penalties imposed by the buyers.

From the time carrier signs for shipment, Vitro no longer has title to the merchandise, and carrier becomes the agent of the consignee. Disposition of shipments refused by consignee is the responsibility of the consignee and or buyer.

Any additional shipping charges incurred by Vitro for matters such as C.O.D. fees, inside delivery, etc., will be billed to the buyer.

Where the shipment of two or more orders is to be consolidated, this information must be stated on at least one order. Generally, shipment of the earlier order will be delayed until the second or last order is ready to be shipped.

## Shortages or Damage Claims

Vitro is not responsible for loss or damages incurred in transit. Before accepting the merchandise from the carrier, the consignee should inspect and note any loss or damage on the delivery receipt. If there is loss or damage, a claim should be made immediately with the carrier. If damage or loss is discovered after delivery, the carrier should be notified immediately for an inspection of concealed damage as well as for instructions in filing a freight claim. Original packing materials should be saved for inspection if claim is to be filed. Concealed damage claims must be filed with carrier within 10 days of receipt of goods. (Freight company deserves the right to refuse responsibility.)

Shortages other than loss in transit, or any variance in the specifications of the order must be reported to Vitro within 10 days of receipt of goods. Failure to make such claim shall constitute acceptance of the merchandise and a waiver of any defects, errors or shortages.

Vitro's liability shall be limited to the selling price of any defective goods, and shall at no time include profits or loss of profits. All replacement orders for freight - damaged merchandise must be accompanied by a completed and signed copy of the carrier's inspection report.

## Returns

No returned merchandise will be accepted by Vitro for exchange, credit or repair unless prior written consent is given by the factory. Unauthorized returns will be refused and returned to the consignee freight collect.

Where returns are authorized, Vitro will issue a Return Authorization Form with shipping instructions which must be used with such returns indicating any restocking and/or freight charges that will be billed to the buyer.

Restocking charges will range from 25% of the original purchase price.

## Storage

If buyer is unable or unwilling to accept delivery when the order is ready, Vitro will invoice the buyer for all handling, transfer and storage costs incurred from the scheduled ship date until the actual shipping date.

Under normal circumstances, if buyer advises at time of placing order that shipment should be made after a specified date, Vitro will try to accomplish such requests. However, if no specific date was requested, and when the order is ready for shipment, buyer is unable or unwilling to accept delivery, Vitro will invoice the buyer for all handling, transfer and storage costs incurred from the scheduled date until actual shipping date. Where buyer requests that Vitro production be halted on an order for a period of time, and materials cannot be diverted to fill other orders, Vitro will determine the storage requirements for such “in process” materials and charge buyer accordingly .

## Product Specifications

Frequently, new production techniques and materials are implemented in order to improve quality, durability or efficiency. Vitro reserves the right to incorporate new materials or make minor modifications in design, construction, wood finishing, upholstery, or in the dimensions of its product line, without prior notice. The uniqueness in the manufacture of certain items may cause slight variations in the dimensions, weights or other specifications found in this price list.

## Flame Retardancy

Municipal requirements regarding flame retardant for use in various types of facilities are constantly changing. As part of our customized service, Vitro offers a wide variety of upholstery and barrier cloths to meet unique flame retardant specifications.

If buyer must satisfy a particular code, e.g., State of Calif. Technical Bulletin 117 - E, or Boston Fire Dept. Code ( *BFD 9-1* ), this must be clearly indicated on the purchase order.

Vitro will advise buyer of special pricing for this service, but Vitro is not liable for noncompliance with local code requirements if the buyer fails to advise Vitro of these requirements at the time of purchase.

*Note, most flame retardant treatments are salt solutions. Cleaning flame retardant upholstery therefore with water or water - based foams will result in salt ringing. Solvent - based fabric cleaners or dry cleaning are alternate methods of cleaning. However, buyer is cautioned to test proposed cleaning procedures on a small portion of fabric before proceeding with cleaning of the entire installation.*

## Limited Warranty & Lifetime Warranty

All products manufactured by Vitro Seating Products are guaranteed against failure from defective workmanship to the original purchaser, when installed and utilized for their intended purpose. A structural frame warranty applies to weld failures and leg bending. The **structural frame warranties** are as follows:

Innovations ( <i>Lifetime</i> )	Parlor ( <i>Lifetime</i> )	265 (2 years)	Wood Chairs (1 year)
Legends ( <i>Lifetime</i> )	Classic ( <i>Lifetime</i> )	300 ( <i>Lifetime</i> )	Booths (3 years)
Spectrum ( <i>Lifetime</i> )	215 (2 years)	400 ( <i>Lifetime</i> )	Solid Wood Tables (1 years)
Omni ( <i>Lifetime</i> )	250 ( <i>Lifetime</i> )	500 ( <i>Lifetime</i> )	Tables (2 years)
Oxford ( <i>Lifetime</i> )	264 ( <i>Lifetime</i> )	1500/1700/1800 ( <i>Lifetime</i> )	Bases (2 years)
Stacker ( <i>Lifetime</i> )		Cafe ( <i>Varies</i> )	Outdoor (1 year)

## Structural Frame Warranty

Does not apply to any product that has been altered, or subjected to misuse, negligence or accident. Under this warranty, any product proven to be defective shall be repaired or replaced at our option, free of charge, provided it is returned prepaid as directed. In no case shall liability under this warranty exceed the original purchase price of the defective merchandise. We reserve the right to inspect the defective item at our premises, by our factory personnel, to establish the cause of the alleged product failure.

This warranty shall not apply to any product which has been repaired or altered by anyone other than Vitro personnel in any way as to affect, in our judgment, its stability and durability, nor which has been subjected to misuse, negligence, abuse or accident.

Vitro's product line is for indoor use only (***Excluding outdoor furniture***), and therefore any damage caused by exposure to the elements, such as salt - air or ultra violet rays, is not covered by this warranty. Even where Vitro was apprised of the final destination of an order, it is not liable under this warranty if the merchandise ordered was exposed to the elements. This warranty shall not apply to Vitro merchandise which was exposed to harsh or acidic cleaning agents or abrasives.

Vitro reserves the right to make changes at any time, without notice, in materials, dimensions, specifications, equipment, colors, design or prices. Vitro also reserves the right to make such changes at any time without any obligation to make comparable revisions and/or modifications on products manufactured at a previous time.

The cost of field repairs performed by non - Vitro personnel will not be reimbursed unless expressly authorized in writing by Vitro prior to the repair.

Vitro Seating Products does exclude upholstery from this warranty, whether the material is provided by Vitro or as COM (*Customers Own Material*). However, warranties are often provided by the upholstery mill. All upholstery and laminates are subject to warranty offered by the respective manufacturer.

## Maintenance

To ensure durability and longevity of Vitro's product line and customer satisfaction, periodic inspection and maintenance is necessary. Buyers should therefore advise their clients to inspect merchandise at regular intervals — particularly the joints, welds, swivels and other points of stress as well as missing glides, screws or bolts, and to clean and tighten screws and bolts, and grease parts where necessary. If repair parts are

needed, use only Vitro replacement parts and attachment methods. If an item shows any sign of structural fatigue, it should be taken out of service immediately. If covered by warranty, Vitro should be notified immediately. Any continued use of the product is at buyer's risk and Vitro's warranty will no longer be valid.

### **Freight quotes are valid for 30 days.**

#### **Upholstery Grades**

Seabrook	Grade 1
Tahoe-Interweave	Grade 1
Modena	Grade 2
Zander	Grade 2
Colorguard NFR	Grade 3
Patriot Plus	Grade 4
Whisper	Grade 4
Classic	Grade 5
Polaris	Grade 5
Sequest	Grade 5
Silvertex	Grade 5
Symphony Vintage	Grade 5
Symphony Glaze	Grade 5
Spirit Millenium	Grade 5
Cracked Ice	Grade 6
Zodiac	Grade 6
Connect	Grade 7
Bleeker	Grade 7



# CHAIRS & STOOLS

# Innovations Series

\*All Innovation Frames Are Painted Only



## INN - 2100

### Features

32" H x 18" W x 18" D  
18" Seat Height  
1 1/4" Pulled Seat  
1 1/4" Sq. Steel Tubing (16 Gauge)  
#18 Butyrate Heavy Duty Glide

### Optional:

3/4" Wood Seat (Add 98.81 Grade 1)

Quantity	Grade 1	Grade 2	Grade 3	Grade 4	Grade 5
100+	370.31	375.90	381.48	387.06	392.66
50 - 99	375.90	381.48	387.06	392.66	398.24
11 - 49	381.48	387.06	392.66	398.24	403.85
1 - 10	460.60	466.73	472.88	479.05	485.16

COM Yardage: 1/2 yd. - price @ GR 1  
Items Per Carton: 2

Weight: 18 lbs, Wood 21 lbs  
Shipping Class: 175



## INN - 2110 BS

### Features

41" H x 18" W x 18" D  
30" Seat Height  
1 1/4" Pulled Seat  
1 1/4" Sq. Steel Tubing (16 Gauge)  
#18 Butyrate Heavy Duty Glide

### Optional:

3/4" Wood Seat (Add 98.81 Grade 1)  
24" Seat Height (Add 33.15)

Quantity	Grade 1	Grade 2	Grade 3	Grade 4	Grade 5
7+	444.86	450.43	456.02	461.59	467.17
1 - 6	530.33	536.47	542.61	548.76	554.89

COM Yardage: 1/2 yd. - price @ GR 1  
Items Per Carton: 1

Weight: 25 lbs, Wood 27 lbs  
Shipping Class: 175



## 600 - INN - 2120 BS

### Features

41" H x 17" W x 18" D  
1 1/4" Pulled Seat  
1 1/4" Sq. Steel Tubing (16 Gauge)  
#18 Butyrate Heavy Duty Glide  
#20 DBL Plate Swivel

### Optional:

3/4" Wood Seat (Add 98.81 Grade 1)  
24" or 30" Seat Height

Quantity	Grade 1	Grade 2	Grade 3	Grade 4	Grade 5
7+	549.20	554.76	560.35	565.95	571.52
1 - 6	645.09	651.22	657.37	663.51	669.65

COM Yardage: 1/2 yd. - price @ GR 1  
Items Per Carton: 1

Weight: 30 lbs, Wood 32 lbs  
Shipping Class: 175



## 1800 - INN - 2120 BS

### Features

41" H x 17" W x 18" D  
1 1/4" Pulled Seat  
3" Sq. Column w/ Cast Iron Bottom  
#22 DBL Plate Seat Return Swivel

### Optional:

3/4" Wood Seat (Add 98.81 Grade 1)  
18", 24", or 30" Seat Height  
Paint Only Footrest (Shown is 606: Add 157.97)

Quantity	Grade 1	Grade 2	Grade 3	Grade 4	Grade 5
7+	586.43	592.01	597.61	603.19	608.76
1 - 6	686.07	692.19	698.35	704.50	710.63

COM Yardage: 1/2 yd. - price @ GR 1  
Items Per Carton: Varies

Weight: 36 lbs, Wood 38 lbs  
Specify Floor Attachment:  
Type B (Wood)  
Type C (Concrete)

\*Footrest not available on 18"

# Curved Wood Back

\*All Innovation Frames Are Painted Only



## INN - 2200

### Features

32" H x 18" W x 18" D  
18" Seat Height  
1 1/4" Pulled Seat  
1 1/4" Sq. Steel Tubing (16 Gauge)  
#18 Butyrate Heavy Duty Glide

### Optional:

3/4" Wood Seat (Add 98.81 Grade 1)

Quantity	Grade 1	Grade 2	Grade 3	Grade 4	Grade 5
100+	319.54	325.12	330.70	336.29	341.86
50 - 99	325.12	330.70	336.29	341.86	347.45
11 - 49	330.70	336.29	341.86	347.45	353.04
1 - 10	404.76	410.90	417.05	423.18	429.34

COM Yardage: 1/2 yd. - price @ GR 1  
Items Per Carton: 2

Weight: 18 lbs, Wood 21 lbs  
Shipping Class: 175



## INN - 2210 BS

### Features

41" H x 18" W x 18" D  
30" Seat Height  
1 1/4" Pulled Seat  
1 1/4" Sq. Steel Tubing (16 Gauge)  
#18 Butyrate Heavy Duty Glide

### Optional:

3/4" Wood Seat (Add 98.81 Grade 1)  
24" Seat Height (Add 33.15)

Quantity	Grade 1	Grade 2	Grade 3	Grade 4	Grade 5
7+	394.06	399.65	405.21	410.81	416.39
1 - 6	474.44	480.59	486.72	492.87	499.02

COM Yardage: 1/2 yd. - price @ GR 1  
Items Per Carton: 1

Weight: 25 lbs, Wood 27 lbs  
Shipping Class: 175



## 600 - INN - 2220 BS

### Features

41" H x 17" W x 18" D  
1 1/4" Pulled Seat  
1 1/4" Sq. Steel Tubing (16 Gauge)  
#18 Butyrate Heavy Duty Glide  
#20 DBL Plate Swivel

### Optional:

3/4" Wood Seat (Add 98.81 Grade 1)  
24" or 30" Seat Height

Quantity	Grade 1	Grade 2	Grade 3	Grade 4	Grade 5
7+	493.35	498.95	504.53	510.12	515.72
1 - 6	589.21	595.36	601.51	607.64	613.79

COM Yardage: 1/2 yd. - price @ GR 1  
Items Per Carton: 1

Weight: 30 lbs, Wood 32 lbs  
Shipping Class: 175



## 1800 - INN - 2220 BS

### Features

41" H x 17" W x 18" D  
1 1/4" Pulled Seat  
3" Sq. Column w/ Cast Iron Bottom  
#22 DBL Plate Seat Return Swivel

### Optional:

3/4" Wood Seat (Add 98.81 Grade 1)  
18", 24", or 30" Seat Height  
Paint Only Footrest (Shown is 606: Add 157.97)

Quantity	Grade 1	Grade 2	Grade 3	Grade 4	Grade 5
7+	535.65	541.23	546.83	552.40	557.99
1 - 6	630.19	636.34	642.49	648.62	654.76

COM Yardage: 1/2 yd. - price @ GR 1  
Items Per Carton: Varies

Weight: 36 lbs, Wood 38 lbs  
Specify Floor Attachment:  
Type B (Wood)  
Type C (Concrete)

\*Footrest not available on 18"

# Round Wood Back

\*All Innovation Frames Are Painted Only



## INN - 2300

### Features

32" H x 18" W x 18" D  
18" Seat Height  
1 1/4" Pulled Seat  
1 1/4" Sq. Steel Tubing (16 Gauge)  
#18 Butyrate Heavy Duty Glide

### Optional:

3/4" Wood Seat (Add 98.81 Grade 1)

Quantity	Grade 1	Grade 2	Grade 3	Grade 4	Grade 5
100+	353.13	358.72	364.30	369.89	375.48
50 - 99	358.72	364.30	369.89	375.48	381.05
11 - 49	364.30	369.89	375.48	381.05	386.64
1 - 10	441.71	447.87	454.03	460.15	466.29

COM Yardage: 1/2 yd. - price @ GR 1  
Items Per Carton: 2

Weight: 18 lbs, Wood 21 lbs  
Shipping Class: 175



## INN - 2310 BS

### Features

41" H x 18" W x 18" D  
30" Seat Height  
1 1/4" Pulled Seat  
1 1/4" Sq. Steel Tubing (16 Gauge)  
#18 Butyrate Heavy Duty Glide

### Optional:

3/4" Wood Seat (Add 98.81 Grade 1)  
24" Seat Height (Add 33.15)

Quantity	Grade 1	Grade 2	Grade 3	Grade 4	Grade 5
7+	427.67	433.26	438.83	444.41	450.01
1 - 6	511.40	517.55	523.70	529.83	535.98

COM Yardage: 1/2 yd. - price @ GR 1  
Items Per Carton: 1

Weight: 25 lbs, Wood 27 lbs  
Shipping Class: 175



## 600 - INN - 2320 BS

### Features

41" H x 17" W x 18" D  
1 1/4" Pulled Seat  
1 1/4" Sq. Steel Tubing (16 Gauge)  
#18 Butyrate Heavy Duty Glide  
#20 DBL Plate Swivel

### Optional:

3/4" Wood Seat (Add 98.81 Grade 1)  
24" or 30" Seat Height

Quantity	Grade 1	Grade 2	Grade 3	Grade 4	Grade 5
7+	532.00	537.58	543.18	548.76	554.34
1 - 6	626.19	632.33	638.49	644.61	650.77

COM Yardage: 1/2 yd. - price @ GR 1  
Items Per Carton: 1

Weight: 30 lbs, Wood 32 lbs  
Shipping Class: 175



## 1800 - INN - 2320 BS

### Features

41" H x 17" W x 18" D  
1 1/4" Pulled Seat  
3" Sq. Column w/ Cast Iron Bottom  
#22 DBL Plate Seat Return Swivel

### Optional:

3/4" Wood Seat (Add 98.81 Grade 1)  
18", 24", or 30" Seat Height  
Paint Only Footrest (Shown is 606: Add 157.97)

Quantity	Grade 1	Grade 2	Grade 3	Grade 4	Grade 5
7+	569.27	574.85	580.44	586.00	591.60
1 - 6	667.20	673.32	679.46	685.62	691.74

COM Yardage: 1/2 yd. - price @ GR 1  
Items Per Carton: Varies

Weight: 36 lbs, Wood 38 lbs  
Specify Floor Attachment:  
Type B (Wood)  
Type C (Concrete)

\*Footrest not available on 18"

# Wood & Metal Lattice Back

\*All Innovation Frames Are Painted Only



## INN - 2400

### Features

32" H x 18" W x 18" D  
18" Seat Height  
1 1/4" Pulled Seat  
1 1/4" Sq. Steel Tubing (16 Gauge)  
#18 Butyrate Heavy Duty Glide

### Optional:

3/4" Wood Seat (Add 98.81 Grade 1)

Quantity	Grade 1	Grade 2	Grade 3	Grade 4	Grade 5
100+	319.54	325.12	330.70	336.29	341.86
50 - 99	325.12	330.70	336.29	341.86	347.45
11 - 49	330.70	336.29	341.86	347.45	353.04
1 - 10	404.76	410.91	417.05	423.19	429.33

COM Yardage: 1/2 yd. - price @ GR 1  
Items Per Carton: 2

Weight: 18 lbs, Wood 21 lbs  
Shipping Class: 175



## INN - 2410 BS

### Features

41" H x 18" W x 18" D  
30" Seat Height  
1 1/4" Pulled Seat  
1 1/4" Sq. Steel Tubing (16 Gauge)  
#18 Butyrate Heavy Duty Glide

### Optional:

3/4" Wood Seat (Add 98.81 Grade 1)  
24" Seat Height (Add 33.15)

Quantity	Grade 1	Grade 2	Grade 3	Grade 4	Grade 5
7+	394.06	399.65	405.21	410.81	416.39
1 - 6	474.44	480.59	486.72	492.87	499.02

COM Yardage: 1/2 yd. - price @ GR 1  
Items Per Carton: 1

Weight: 25 lbs, Wood 27 lbs  
Shipping Class: 175



## 600 - INN - 2420 BS

### Features

41" H x 17" W x 18" D  
1 1/4" Pulled Seat  
1 1/4" Sq. Steel Tubing (16 Gauge)  
#18 Butyrate Heavy Duty Glide  
#20 DBL Plate Swivel

### Optional:

3/4" Wood Seat (Add 98.81 Grade 1)  
24" or 30" Seat Height

Quantity	Grade 1	Grade 2	Grade 3	Grade 4	Grade 5
7+	493.36	498.95	504.53	510.13	515.72
1 - 6	589.21	595.36	601.51	607.64	613.79

COM Yardage: 1/2 yd. - price @ GR 1  
Items Per Carton: 1

Weight: 30 lbs, Wood 32 lbs  
Shipping Class: 175



## 1800 - INN - 2420 BS

### Features

41" H x 17" W x 18" D  
1 1/4" Pulled Seat  
3" Sq. Column w/ Cast Iron Bottom  
#22 DBL Plate Seat Return Swivel

### Optional:

3/4" Wood Seat (Add 98.81 Grade 1)  
18", 24", or 30" Seat Height  
Paint Only Footrest (Shown is 606: Add 157.97)

Quantity	Grade 1	Grade 2	Grade 3	Grade 4	Grade 5
7+	535.65	541.23	546.83	552.40	557.99
1 - 6	630.19	636.34	642.49	648.62	654.76

COM Yardage: 1/2 yd. - price @ GR 1  
Items Per Carton: Varies

Weight: 36 lbs, Wood 38 lbs  
Specify Floor Attachment:  
Type B (Wood)  
Type C (Concrete)

\*Footrest not available on 18"

# Wood & Metal Criss Cross Back

\*All Innovation Frames Are Painted Only



## INN - 2500

### Features

32" H x 18" W x 18" D  
18" Seat Height  
1 1/4" Pulled Seat  
1 1/4" Sq. Steel Tubing (16 Gauge)  
#18 Butyrate Heavy Duty Glide

### Optional:

3/4" Wood Seat (Add 98.81 Grade 1)

Quantity	Grade 1	Grade 2	Grade 3	Grade 4	Grade 5
100+	319.54	325.12	330.70	336.29	341.86
50 - 99	325.12	330.70	336.29	341.86	347.45
11 - 49	330.70	336.29	341.86	347.45	353.04
1 - 10	404.76	410.91	417.05	423.19	429.33

COM Yardage: 1/2 yd. - price @ GR 1  
Items Per Carton: 2

Weight: 18 lbs, Wood 21 lbs  
Shipping Class: 175



## INN - 2510 BS

### Features

41" H x 18" W x 18" D  
30" Seat Height  
1 1/4" Pulled Seat  
1 1/4" Sq. Steel Tubing (16 Gauge)  
#18 Butyrate Heavy Duty Glide

### Optional:

3/4" Wood Seat (Add 98.81 Grade 1)  
24" Seat Height (Add 33.15)

Quantity	Grade 1	Grade 2	Grade 3	Grade 4	Grade 5
7+	394.06	399.65	405.21	410.81	416.39
1 - 6	474.44	480.59	486.72	492.87	499.02

COM Yardage: 1/2 yd. - price @ GR 1  
Items Per Carton: 1

Weight: 25 lbs, Wood 27 lbs  
Shipping Class: 175



## 600 - INN - 2520 BS

### Features

41" H x 17" W x 18" D  
1 1/4" Pulled Seat  
1 1/4" Sq. Steel Tubing (16 Gauge)  
#18 Butyrate Heavy Duty Glide  
#20 DBL Plate Swivel

### Optional:

3/4" Wood Seat (Add 98.81 Grade 1)  
24" or 30" Seat Height

Quantity	Grade 1	Grade 2	Grade 3	Grade 4	Grade 5
7+	493.36	498.95	504.53	510.13	515.72
1 - 6	589.21	595.36	601.51	607.64	613.79

COM Yardage: 1/2 yd. - price @ GR 1  
Items Per Carton: 1

Weight: 30 lbs, Wood 32 lbs  
Shipping Class: 175



## 1800 - INN - 2520 BS

### Features

41" H x 17" W x 18" D  
1 1/4" Pulled Seat  
3" Sq. Column w/ Cast Iron Bottom  
#22 DBL Plate Seat Return Swivel

### Optional:

3/4" Wood Seat (Add 98.81 Grade 1)  
18", 24", or 30" Seat Height  
Paint Only Footrest (Shown is 606: Add 157.87)

\*Footrest not available on 18"

Quantity	Grade 1	Grade 2	Grade 3	Grade 4	Grade 5
7+	535.65	541.23	546.83	552.40	557.99
1 - 6	630.19	636.34	642.49	648.62	654.76

COM Yardage: 1/2 yd. - price @ GR 1  
Items Per Carton: Varies

Weight: 36 lbs, Wood 38 lbs  
Specify Floor Attachment:  
Type B (Wood)  
Type C (Concrete)

# Curved Wood Back & Metal Slats

\*All Shown With Optional Wood Seat \*All Innovation Frames Are Painted Only



## INN - 2600

### Features

32" H x 18" W x 18" D  
18" Seat Height  
1 1/4" Pulled Seat  
1 1/4" Sq. Steel Tubing (16 Gauge)  
#18 Butyrate Heavy Duty Glide

### Optional:

3/4" Wood Seat (Add 98.81 Grade 1)

Quantity	Grade 1	Grade 2	Grade 3	Grade 4	Grade 5
100+	331.28	337.79	342.44	348.04	353.60
50 - 99	336.85	342.44	348.04	353.60	359.19
11 - 49	342.44	348.04	353.60	359.19	364.79
1 - 10	417.68	423.83	429.97	436.11	442.25

COM Yardage: 1/2 yd. - price @ GR 1

Items Per Carton: 2

Weight: 18 lbs, Wood 21 lbs

Shipping Class: 175



## INN - 2610 BS

### Features

41" H x 18" W x 18" D  
30" Seat Height  
1 1/4" Pulled Seat  
1 1/4" Sq. Steel Tubing (16 Gauge)  
#18 Butyrate Heavy Duty Glide

### Optional:

3/4" Wood Seat (Add 98.81 Grade 1)

24" Seat Height (Add 33.15)

Quantity	Grade 1	Grade 2	Grade 3	Grade 4	Grade 5
7+	405.78	411.38	416.96	422.54	428.13
1 - 6	487.36	493.51	499.64	505.79	511.94

COM Yardage: 1/2 yd. - price @ GR 1

Items Per Carton: 1

Weight: 25 lbs, Wood 27 lbs

Shipping Class: 175



## 600 - INN - 2620 BS

### Features

41" H x 17" W x 18" D  
1 1/4" Pulled Seat  
1 1/4" Sq. Steel Tubing (16 Gauge)  
#18 Butyrate Heavy Duty Glide  
#20 DBL Plate Swivel

### Optional:

3/4" Wood Seat (Add 98.81 Grade 1)

24" or 30" Seat Height

Quantity	Grade 1	Grade 2	Grade 3	Grade 4	Grade 5
7+	510.12	515.72	521.29	526.87	532.47
1 - 6	602.13	608.28	614.43	620.56	626.70

COM Yardage: 1/2 yd. - price @ GR 1

Items Per Carton: 1

Weight: 30 lbs, Wood 32 lbs

Shipping Class: 175



## 1800 - INN - 2620 BS

### Features

41" H x 17" W x 18" D  
1 1/4" Pulled Seat  
3" Sq. Column w/ Cast Iron Bottom  
#22 DBL Plate Seat Return Swivel

### Optional:

3/4" Wood Seat (Add 98.81 Grade 1)

18", 24", or 30" Seat Height

Paint Only Footrest (Shown is 606: Add 157.87)

Quantity	Grade 1	Grade 2	Grade 3	Grade 4	Grade 5
7+	547.39	552.99	558.56	564.14	569.73
1 - 6	643.10	649.25	655.39	661.53	667.67

COM Yardage: 1/2 yd. - price @ GR 1

Items Per Carton: Varies

Weight: 36 lbs, Wood 38 lbs

Specify Floor Attachment:

Type B (Wood)

Type C (Concrete)

\*Footrest not available on 18"

# Cafe Collection



## MAN- 200

### Features

35" H x 19½" W x 19" D  
18" Seat Height Only  
18 Gauge Steel Frame  
Non-Marring Plastic Glides

### Optional

Available in Vintage Black, Vintage White, or Gray  
Metal or Wood Seat (Add 48.51 Grade 1)

Quantity	Grade 1	Grade 2	Grade 3	Grade 4	Grade 5
100+	Call Factory for pricing / availability				
50 – 99	Please include quantities when inquiring				
11 – 49	Call Factory for pricing / availability				
1 – 10	Please include quantities when inquiring				

COM Yardage: ½ yd. - price @ GR 1

Weight: 18 lbs

Items Per Carton: 2

Shipping Class: 175



## PLM - 100

### Features

32" H x 18" W x 18" D  
18" Seat Height  
1¼" Pulled Seat  
1¼" Sq. Steel Tubing (16 Gauge)  
#18 Butyrate Heavy Duty Glide

### Optional:

¾" Wood Seat (Add 98.81 Grade 1)

Quantity	Grade 1	Grade 2	Grade 3	Grade 4	Grade 5
100+	Call Factory for pricing / availability				
50 – 99	Please include quantities when inquiring				
11 – 49	Call Factory for pricing / availability				
1 – 10	Please include quantities when inquiring				

COM Yardage: ½ yd. - price @ GR 1

Weight: 18 lbs, Wood 21 lbs

Items Per Carton: 2

Shipping Class: 175



## PLM - 1100 BS

### Features

41" H x 18" W x 18" D  
30" Seat Height  
1¼" Pulled Seat  
1¼" Sq. Steel Tubing (16 Gauge)  
#18 Butyrate Heavy Duty Glide

### Optional:

¾" Wood Seat (Add 98.81 Grade 1)

24" Seat Height (Add 33.15)

Quantity	Grade 1	Grade 2	Grade 3	Grade 4	Grade 5
7+	Call Factory for pricing / availability				
1-6	Please include quantities when inquiring				

COM Yardage: ½ yd. - price @ GR 1

Weight: 25 lbs, Wood 27 lbs

Items Per Carton: 1

Shipping Class: 175

# Minimum Quantity Shown For Each Item



## HPN - 100

### Features

33" H x 20" D x 18½" W

18" Seat Height

### Aluminum Chair

1 Year Structural Frame Warranty

### Optional:

Powder Coat Paint (*Call Factory for pricing*)

(*Shown with Cardinal Paint*)

Available in all paint colors

### Quantity

100+	Call Factory for pricing / availability
50 – 99	Please include quantities when inquiring
11 – 49	Call Factory for pricing / availability
1 – 10	Please include quantities when inquiring

COM Yardage: N/A

Weight: 9 lbs

Items Per Carton: 2

Shipping Class: 175



## HPN - 1100 BS

### Features

42" H x 19" D x 16" W

30" Seat Height

### Aluminum Stool

1 Year Structural Frame Warranty

### Optional:

Powder Coat Paint (*Call Factory for pricing*)

### Quantity

7+	Call Factory for pricing / availability
1-6	Please include quantities when inquiring

COM Yardage: N/A

Weight: 15 lbs

Items Per Carton: 1

Shipping Class: 250

## Minimum Quantity Shown For Each Item



### MAD - 100

#### Features

35½" H x 17½" W x 17" D  
 18" Seat Height  
 1¼" Pulled Seat  
 1" Rd. Steel Tubing (16 Gauge)  
 Beechwood Back Panel  
 J.I.B Glides  
 Lifetime Structural Frame Warranty

Quantity	Grade 1	Grade 2	Grade 3	Grade 4	Grade 5
100+	333.52	339.10	344.69	350.25	355.84
50 – 99	339.10	344.69	350.25	355.84	361.44
11 – 49	344.69	350.25	355.84	361.44	367.01
1 – 10	420.12	426.27	432.40	438.55	444.69

COM Yardage: ½ yd. - price @ GR 1  
 Items Per Carton: 2

Weight: 18 lbs  
 Shipping Class: 175



### MAD - 1100 BS

#### Features

43" H x 17½" W x 17" D  
 30" Seat Height  
 1¼" Pulled Seat  
 1" Rd. Steel Tubing (16 Gauge)  
 Beechwood Back Panel  
 J.I.B Glides  
 Lifetime Structural Frame Warranty

Quantity	Grade 1	Grade 2	Grade 3	Grade 4	Grade 5
7+	411.78	417.35	422.93	428.53	434.10
1 – 6	493.92	500.08	506.20	512.36	518.50

COM Yardage: ½ yd. - price @ GR 1  
 Items Per Carton: 1

Weight: 25 lbs  
 Shipping Class: 175



### MKT - 100

#### Features

31" H x 16½" W x 17" D  
 18" Seat Height  
 Curved Plywood Seat & Back  
 Tapered Metal Legs  
 Powder Coated Gloss Black Frame  
 Black Cap Glides  
 Natural Wood Stain Only  
 1 Year Structural Frame Warranty

Quantity	
100+	Call Factory for pricing / availability
50 – 99	Please include quantities when inquiring
11 – 49	Call Factory for pricing / availability
1 – 10	Please include quantities when inquiring

COM Yardage: N/A  
 Items Per Carton: 2

Weight: 12 lbs  
 Shipping Class: 175



### MKT - 1100 BS

#### Features

43" H x 16½" W x 17" D  
 30" Seat Height  
 Curved Plywood Seat & Back  
 Tapered Metal Legs  
 Powder Coated Gloss Black Frame  
 Black Cap Glides  
 Natural Wood Stain Only  
 1 Year Structural Frame Warranty

Quantity	
7+	Call Factory for pricing / availability
1-6	Please include quantities when inquiring

COM Yardage: N/A  
 Items Per Carton: 1

Weight: 15 lbs  
 Shipping Class: 175

## Minimum Quantity Shown For Each Item



### TUK - 100

#### Features

34" H x 17¼" W x 20" D  
 18" Seat Height  
 1" Sq. Steel Tubing (16 Gauge)  
 #1 Heavy Duty Platform Glides  
 Powder Coated Frame Only  
 (All Colors)  
 Rustic Walnut Seat & Back

#### Quantity

100+	345.65
50 - 99	350.60
11 - 49	355.56
1 - 10	427.54

COM Yardage: N/A

Weight: 21 lbs

Items Per Carton: 2



### TUK - 1100 BS

#### Features

40½" H x 17¼" W x 20" D  
 24" or 30" Seat Height  
 1" Sq. Steel Tubing (16 Gauge)  
 #1 Heavy Duty Platform Glides  
 Powder Coated Frame Only  
 (All Colors)  
 Rustic Walnut Seat & Back

#### Quantity

100+	388.69
50 - 99	393.66
11 - 49	398.62
1 - 10	474.91

COM Yardage: N/A

Weight: 26 lbs

Items Per Carton: 1



### TUK - 1150 BS

#### Features

30½" H x 17¼" W x 20" D  
 24" or 30" Seat Height  
 1" Sq. Steel Tubing (16 Gauge)  
 #1 Heavy Duty Platform Glides  
 Powder Coated Frame Only  
 (All Colors)  
 Rustic Walnut Seat

#### Quantity

100+	337.99
50 - 99	342.95
11 - 49	347.91
1 - 10	419.14

COM Yardage: N/A

Weight: 21 lbs

Items Per Carton: 1



**The Tucker Series is available with upholstered seats.**

**Upholstery selections are available up to Grade 3.**

*Minimum Quantity Shown For Each Item*



## Minimum Quantity Shown For Each Item



### BRD - 1000 BS

#### Features

30" H x 15½" W x 15½" D  
 30" Seat Height Only  
 1¼" Sq. Steel Tubing (16 Gauge)  
 1¼" Pulled Seat  
 Powder Coated Frame  
 #18 Butyrate Glides  
 Non - Swivel  
 Lifetime Structural Frame Warranty

Quantity	Grade 1	Grade 2	Grade 3	Grade 4	Grade 5
7+	260.81	266.38	271.97	277.56	283.14
1 - 6	327.86	333.99	340.14	346.28	352.41

COM Yardage: ½ yd. - price @ GR 1

Weight: 18 lbs

Items Per Carton: 1

Shipping Class: 250



### BRD - 1100 BS

#### Features

42" H x 15½" W x 15½" D  
 30" Seat Height Only  
 1¼" Sq. Steel Tubing (16 Gauge)  
 1¼" Pulled Seat  
 Powder Coated Frame  
 #18 Butyrate Glides  
 Non - Swivel  
 Lifetime Structural Frame Warranty

Quantity	Grade 1	Grade 2	Grade 3	Grade 4	Grade 5
7+	390.87	396.46	402.02	407.59	413.18
1 - 6	470.93	477.06	483.21	489.35	495.49

COM Yardage: ½ yd. - price @ GR 1

Weight: 27 lbs

Items Per Carton: 1

Shipping Class: 175

# Delmar Series

*\* Call factory for powder paint options & pricing*



## DM - 100

### Features

33½" H x 18" W x 18" D  
18" Seat Height  
1½ mm Thick Steel Legs  
Clear Coat w/ Rough Brush

### Quantity

100+	Call Factory for pricing / availability
50 - 99	Please include quantities when inquiring
11 - 49	Call Factory for pricing / availability
1 - 10	Please include quantities when inquiring

COM Yardage: NA

Weight: 10 lbs.

Items Per Carton: 4



## DM - 200

### Features

34" H x 18" W x 18" D  
18" Seat Height  
1½ mm Thick Steel Legs  
Clear Coat w/ Rough Brush

### Quantity

100+	Call Factory for pricing / availability
50 - 99	Please include quantities when inquiring
11 - 49	Call Factory for pricing / availability
1 - 10	Please include quantities when inquiring

COM Yardage: NA

Weight: 11 lbs

Items Per Carton: 2



## DM - 1100 BS

### Features

46" H x 20" W x 20" D  
30" Seat Height  
1½ mm Thick Steel Legs  
Clear Coat w/ Rough Brush

### Quantity

7+	Call Factory for pricing / availability
1-6	Please include quantities when inquiring

COM Yardage: NA

Weight: 15 lbs

Items Per Carton: 1



## DM - 1200 BS

### Features

30" H x 18" W x 18" D  
30" Seat Height  
1½ mm Thick Steel Legs  
Clear Coat w/ Rough Brush

### Quantity

7+	Call Factory for pricing / availability
1-6	Please include quantities when inquiring

COM Yardage: NA

Weight: 10 lbs

Items Per Carton: 4

# Manhattan Series



## MAN - 1100 BS

### Features

30" H x 19" W x 19" D  
 30" Seat Height  
 Non - Swivel  
 Solid European Beechwood  
 Upholstered w/ Chrome Nailheads

### Optional:

Cherry, Mahogany, Walnut,  
 and Dark Mahogany Frame

Quantity Grades 1 - 5

7+

Call Factory for pricing / availability

1-6

Please include quantities when inquiring

COM Yardage: ½ yd. - price @ GR 1

Weight: 18 lbs

Items Per Carton: 1

Shipping Class: 250



## MAN - 140

### Features

35" H x 18" W x 22" D  
 18" Seat Height  
 6 Standard Stains

### Optional:

Dark Mahogany, Mahogany,  
 Natural, Walnut, Cherry,  
 and Black Frame

Quantity Grades 1 - 5

100+

Call Factory for pricing / availability

50 - 99

Please include quantities when inquiring

11 - 49

Call Factory for pricing / availability

1 - 10

Please include quantities when inquiring

COM Yardage: 1¼ yds. - price @ GR 1

Weight: 18 lbs

Items Per Carton: 2

Shipping Class: 175



## MAN - 1160 BS

### Features

43½" H x 18½" W x 20" D  
 30" Seat Height  
 Swivels  
 Upholstered w/ Chrome Nailheads

### Optional:

Cherry, Mahogany, Natural,  
 and Walnut Frame

Quantity Grades 1 - 5

7+

Call Factory for pricing / availability

1-6

Please include quantities when inquiring

COM Yardage: 1 yd. - price @ GR 1

Weight: 25 lbs

Items Per Carton: 1

Shipping Class: 175

### Please Note:

*If the back is vinyl, nailheads must be used. If the back is fabric, nailheads are optional. Braces, Chrome, or Black Finish footrest are no-charge but must be specified.*

# "Rule Of Thumb"

## Chair & Table Space Requirements

- 14 sq. ft. per person for spacious dining — allows for table, chair and aisle.

- 12 sq. ft. per person for cafeteria or restaurant.

- 10 sq. ft. per person for banquet, institutional or close seating.

- Allow 18" for person seated from edge of table to back of chair.

- Diagonal seating saves floor space — Deuce tables and wall spacing saves the most space.

- Allow 42" between squared tables for chairs back to back leaves 6" to push out.

- Allow 60" between squared tables for chairs back to back leaves 26" service aisle.

- Allow 24" between corners of diagonal tables for customer access - no aisle.

- Allow 30" between corners of diagonal tables for customer access - narrow aisle.

*\*Note: Where space is limited, booths require only 8 sq. ft. per person including aisle allowance.*

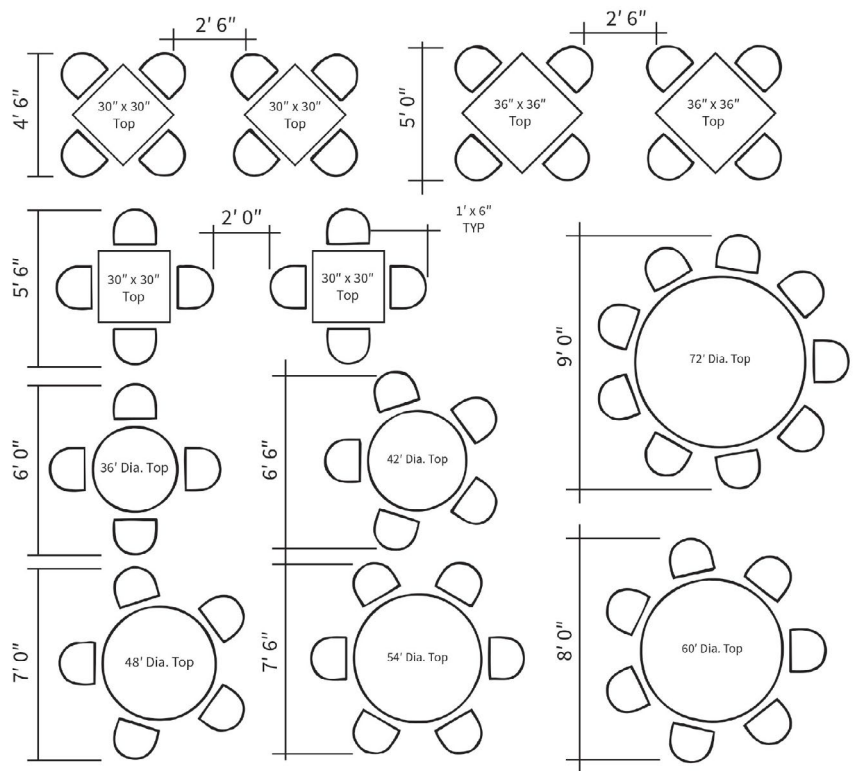



### MAN - 1220 BS

**Features**

44½" H x 18" W x 20" D  
 30" Seat Height  
 Solid Beech Hardwood  
 Gunstock Walnut Frame Only

**Optional:**

Brass Footrest (*Add 18.89*)

Quantity Grades 1 - 5

7+	Call Factory for pricing / availability
1-6	Please include quantities when inquiring

COM Yardage: 1 yd. - price @ GR 1      Weight: 25 lbs  
 Items Per Carton: 1      Shipping Class: 175



### MAN - 250 PS4

**Features**

33½" H x 18" W x 19" D  
 18" Seat Height  
 Upholstered Seat & Back  
 Nail Head Trim

**Optional:**

Dark Mahogany, Mahogany,  
 Natural, Walnut, Cherry,  
 and Black Frame

Quantity Grades 1 - 5

100+	Call Factory for pricing / availability
50 - 99	Please include quantities when inquiring
11 - 49	Call Factory for pricing / availability
1 - 10	Please include quantities when inquiring

COM Yardage: 1¼ yds. - price @ GR 1      Weight: 18 lbs  
 Items Per Carton: 2      Shipping Class: 175



### MAN - 250 PS3

**Features**

33½" H x 18" W x 19" D  
 18" Seat Height  
 Nail Head Trim

**Optional:**

Dark Mahogany, Mahogany,  
 Natural, Walnut, Cherry,  
 and Black Frame

Quantity Grades 1 - 5

100+	Call Factory for pricing / availability
50 - 99	Please include quantities when inquiring
11 - 49	Call Factory for pricing / availability
1 - 10	Please include quantities when inquiring

COM Yardage: 1¼ yds. - price @ GR 1      Weight: 18 lbs  
 Items Per Carton: 2      Shipping Class: 175

## Standard Wood Finishes



Walnut      Black      Cherry      Dark Mahogany      Mahogany      Natural

*\* Finishes are reproduced as accurately as possible, colors may vary from actual product color.*



### MAN - 1250 BS

#### Features

44½" H x 18½" W x 19" D

30" Seat Height

Nail Head Trim

Solid European Beechwood

Reinforced w/ Metal Brackets

#### Optional:

Brass Footrest (*Add 18.89*)

Dark Mahogany, Mahogany,

Natural, Walnut, Cherry,

and Black Frame

Quantity Grades 1 - 5

7+

Call Factory for pricing / availability

1-6

Please include quantities when inquiring

COM Yardage: 1¼ yds. - price @ GR 1

Weight: 25 lbs

Items Per Carton: 1

Shipping Class: 175



### MAN - 300 FP

#### Features

36" H x 17" W x 21" D

18" Seat Height

Upholstered Seat & Back

#### Optional:

Cherry, Mahogany,

and Walnut Frame

Quantity Grades 1 - 5

100+

Call Factory for pricing / availability

50 - 99

Please include quantities when inquiring

11 - 49

Call Factory for pricing / availability

1 - 10

Please include quantities when inquiring

COM Yardage: 1¼ yds. - price @ GR 1

Weight: 18 lbs

Items Per Carton: 2

Shipping Class: 175

*To place your order*

**Fax: 1-800-476-2258**

**Email: [Order@Vitroseating.com](mailto:Order@Vitroseating.com)**

# Woodland Series



Slatback Chair

## WLS - 100

### Features

34½" H x 17½" W x 20½" D  
18" Seat Height  
Solid Beech Hardwood  
Nylon Glide  
6 Standard Stains

### Optional:

¾" Wood Seat (Add 98.81 Grade 1)

Quantity	Grade 1	Grade 2	Grade 3	Grade 4	Grade 5
150+	Call Factory for pricing / availability				
51 - 149	Please include quantities when inquiring				
1 - 50	Call Factory for pricing / availability				

COM Yardage: ½ yd. - price @ GR 1

Weight: 16 lbs, Wood 18 lbs

Items Per Carton: 2

Shipping Class: 175



Slatback Stool

## WLS - 1000 BS

### Features

43½" H x 17½" W x 20½" D  
30" Seat Height  
Solid Beech Hardwood  
Nylon Glide  
6 Standard Stains

### Optional:

¾" Wood Seat (Add 98.81 Grade 1)

Brass Footrest (Add 18.89)

Quantity	Grade 1	Grade 2	Grade 3	Grade 4	Grade 5
7+	Call Factory for pricing / availability				
1 - 6	Please include quantities when inquiring				

COM Yardage: ½ yd. - price @ GR 1

Weight: 21 lbs, Wood 23 lbs

Items Per Carton: 1

Shipping Class: 175



Schoolhouse Chair

## WLS - 180

### Features

39" H x 18" W x 25" D  
18" Seat Height  
Solid Beech Hardwood  
Nylon Glide  
6 Standard Stains  
Wood Seat Only

### Quantity

150+	Call Factory for pricing / availability
51 - 149	Please include quantities when inquiring
1 - 50	Call Factory for pricing / availability

COM Yardage: N/A

Weight: 20 lbs

Items Per Carton: 2

Shipping Class: 175



Schoolhouse Stool

## WLS - 1180 BS

### Features

44½" H x 18¼" W x 20¼" D  
30" Seat Height  
Solid Beech Hardwood  
Nylon Glide  
6 Standard Stains  
Wood Seat Only

### Optional:

Brass Footrest (Add 18.89)

### Quantity

7+	Call Factory for pricing / availability
1 - 6	Please include quantities when inquiring

COM Yardage: N/A

Weight: 25 lbs

Items Per Carton: 1

Shipping Class: 175



**Lattice Back Chair**

**WLS - 200**

**Features**

- 34½" H x 17 ½" W x 21"D
- 18" Seat Height
- Solid Beech Hardwood
- Nylon Glide
- 6 Standard Stains

**Optional:**

¾" Wood Seat (Add 98.81 Grade 1)

Quantity	Grade 1	Grade 2	Grade 3	Grade 4	Grade 5
150+	Call Factory for pricing / availability				
51 - 149	Please include quantities when inquiring				
1 - 50	Call Factory for pricing / availability				

COM Yardage: ½ yd. - price @ GR 1

Weight: 16 lbs, Wood 18 lbs

Items Per Carton: 2

Shipping Class: 175



**Lattice Back Stool**

\* Shown with optional wood seat

**WLS - 1200 BS**

**Features**

- 45" H x 17" W x 22½" D
- 30" Seat Height
- Solid Beech Hardwood
- Nylon Glide
- 6 Standard Stains

**Optional:**

¾" Wood Seat (Add 98.81 Grade 1)

Brass Footrest (Add 18.89)

Quantity	Grade 1	Grade 2	Grade 3	Grade 4	Grade 5
7+	Call Factory for pricing / availability				
1 - 6	Please include quantities when inquiring				

COM Yardage: ½ yd. - price @ GR 1

Weight: 21 lbs, Wood 23 lbs

Items Per Carton: 1

Shipping Class: 175



Ladder Back Chair

### WLS - 300

#### Features

32 1/2" H x 16 1/2" W x 20" D  
 18" Seat Height  
 Solid Beech Hardwood  
 Nylon Glide  
 6 Standard Stains

#### Optional:

3/4" Wood Seat (Add 98.81 Grade 1)

Quantity	Grade 1	Grade 2	Grade 3	Grade 4	Grade 5
----------	---------	---------	---------	---------	---------

150+	Call Factory for pricing / availability				
51 - 149	Please include quantities when inquiring				
1 - 50	Call Factory for pricing / availability				

COM Yardage: 1/2 yd. - price @ GR 1

Weight: 16 lbs, Wood 18 lbs

Items Per Carton: 2

Shipping Class: 175



Ladder Back Stool  
 \* Shown with optional wood seat

### WLS - 1300 BS

#### Features

42 1/2" H x 16" W x 19" D  
 30" Seat Height  
 Solid Beech Hardwood  
 Nylon Glide  
 6 Standard Stains

#### Optional:

3/4" Wood Seat (Add 98.81 Grade 1)

Brass Footrest (Add 18.89)

Quantity	Grade 1	Grade 2	Grade 3	Grade 4	Grade 5
----------	---------	---------	---------	---------	---------

7+	Call Factory for pricing / availability				
1 - 6	Please include quantities when inquiring				

COM Yardage: 1/2 yd. - price @ GR 1

Weight: 21 lbs, Wood 23 lbs

Items Per Carton: 1

Shipping Class: 175



Backless Stool

### WLS - 1310 BS

#### Features

30" H x 16" W x 16" D  
 6 Standard Stains  
 Wood Seat Only  
 Non - Swivel  
 30" H Only

Quantity
----------

7+	Call Factory for pricing / availability
1 - 6	Please include quantities when inquiring

COM Yardage: N/A

Weight: 16 lbs

Items Per Carton: 1

Shipping Class: 250

## Standard Wood Finishes



Walnut

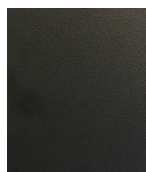

Black

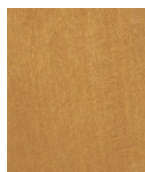

Cherry

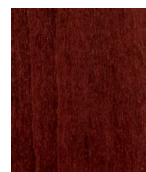

Dark Mahogany



Mahogany



Natural

\* Finishes are reproduced as accurately as possible, colors may vary from actual product color.



**WLS - 568**

**Features**

34½" H x 18¾" W x 17" D  
19" Seat Height

**Optional:**

¾" Wood Seat *(Add 98.81 Grade 1)*

Quantity	Grade 1	Grade 2	Grade 3	Grade 4	Grade 5
----------	---------	---------	---------	---------	---------

150+	Call Factory for pricing / availability				
------	---	--	--	--	--

51 – 149	Please include quantities when inquiring				
----------	--	--	--	--	--

1 – 50	Call Factory for pricing / availability				
--------	---	--	--	--	--

COM Yardage: ½ yd. - price @ GR 1

Weight: 20 lbs, Wood 22 lbs

Items Per Carton: 2

Shipping Class: 175



**WLS - 1568 BS**

**Features**

42" H x 16" W x 19½" D  
30" Seat Height

Solid Beech Hardwood

Nylon Glide

**Optional:**

¾" Wood Seat *(Add 98.81 Grade 1)*

Brass Footrest *(Add 18.89)*

Quantity	Grade 1	Grade 2	Grade 3	Grade 4	Grade 5
----------	---------	---------	---------	---------	---------

7+	Call Factory for pricing / availability				
----	---	--	--	--	--

1 – 6	Please include quantities when inquiring				
-------	--	--	--	--	--

COM Yardage: ½ yd. - price @ GR 1

Weight: 23 lbs, Wood 25 lbs

Items Per Carton: 1

Shipping Class: 175



**WLS - 582**

**Features**

34½" H x 18¾" W x 17" D  
19" Seat Height

Solid Beech Hardwood

Nylon Glide

6 Standard Stains

Quantity	Grade 1	Grade 2	Grade 3	Grade 4	Grade 5
----------	---------	---------	---------	---------	---------

150+	Call Factory for pricing / availability				
------	---	--	--	--	--

51 – 149	Please include quantities when inquiring				
----------	--	--	--	--	--

1 – 50	Call Factory for pricing / availability				
--------	---	--	--	--	--

COM Yardage: ½ yd. - price @ GR 1

Weight: 16 lbs, Wood 18 lbs

Items Per Carton: 2

Shipping Class: 175



**WLS - 1582 BS**

**Features**

42½" H x 17½" W x 20" D  
30" Seat Height

Solid Beech Hardwood

Nylon Glide

6 Standard Stains

**Optional:**

Brass Footrest *(Add 18.89)*

Quantity	Grade 1	Grade 2	Grade 3	Grade 4	Grade 5
----------	---------	---------	---------	---------	---------

7+	Call Factory for pricing / availability				
----	---	--	--	--	--

1 – 6	Please include quantities when inquiring				
-------	--	--	--	--	--

COM Yardage: ½ yd. - price @ GR 1

Weight: 21 lbs, Wood 23 lbs

Items Per Carton: 1

Shipping Class: 175

# Booth Seating

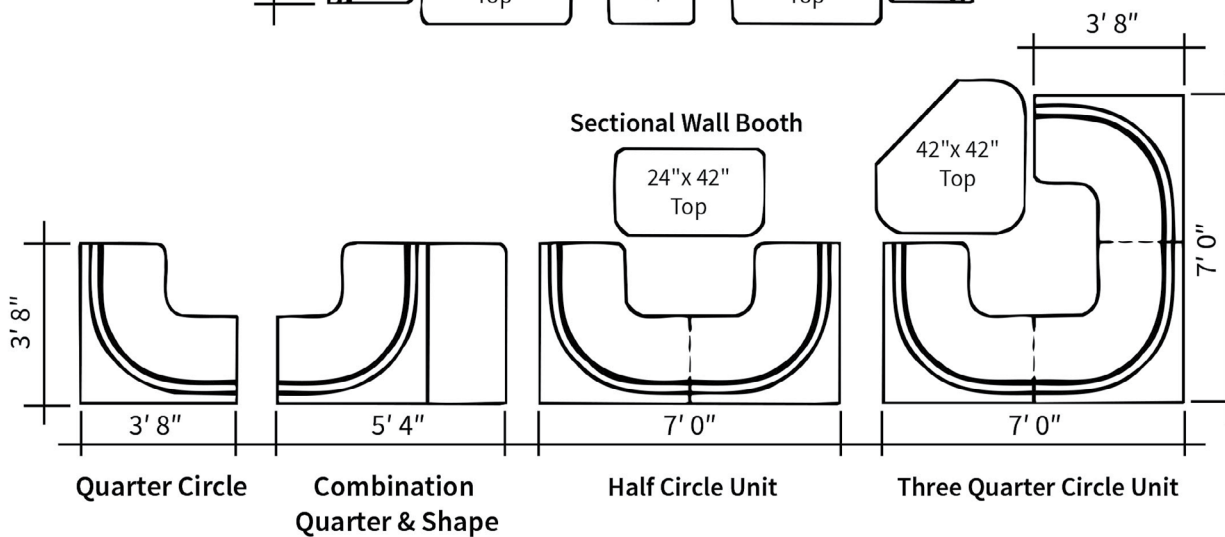
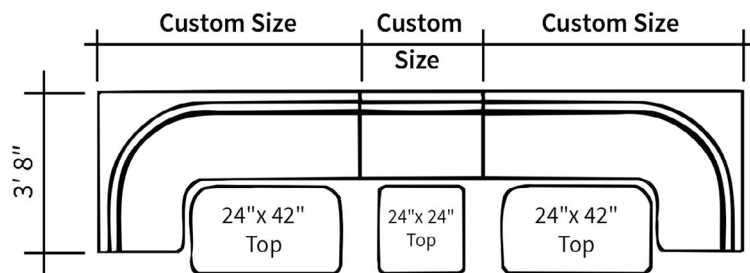
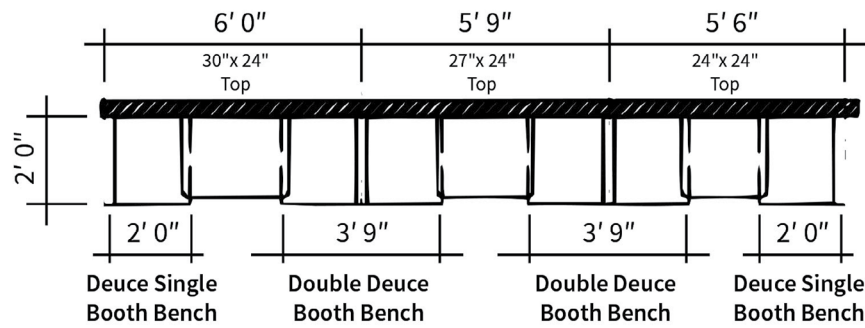
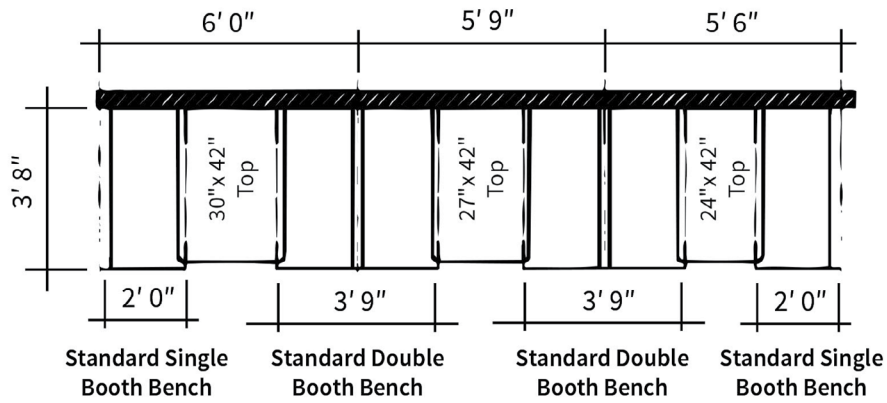

# Typical Counter Stool Position

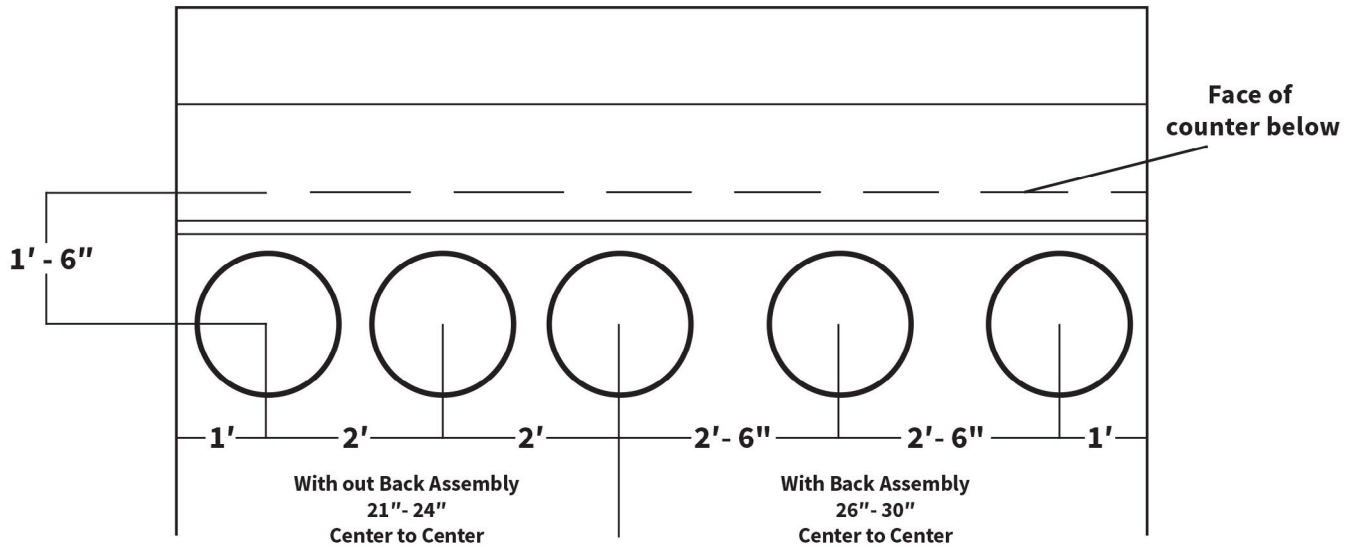

## TYPICAL COUNTER PLAN

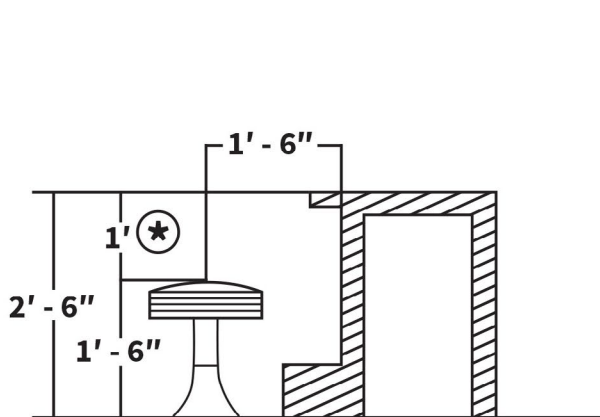

## TYPICAL 30" COUNTER SECTION

\* - 12" Dimension should be held to maintain correct spatial relationships

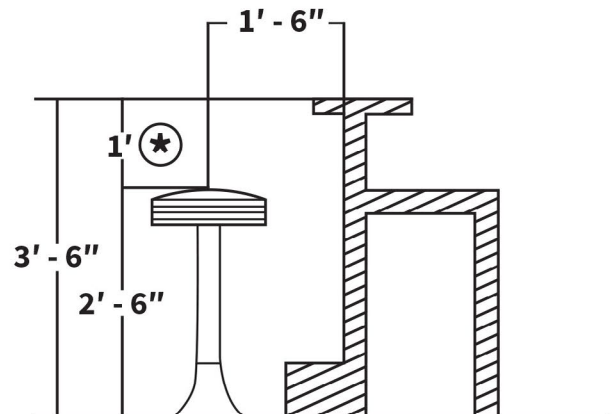

## TYPICAL 42" COUNTER SECTION

\* - 12" Dimension should be held to maintain correct spatial relationships

# "Rule Of Thumb"

## Chair & Table Space Requirements

- 14 sq. ft. per person for spacious dining — allows for table, chair and aisle.
- 12 sq. ft. per person for cafeteria or restaurant.
- 10 sq. ft. per person for banquet, institutional or close seating.
- Allow 18" for person seated from edge of table to back of chair.
- Diagonal seating saves floor space — Deuce tables and wall spacing saves the most space.
- Allow 42" between squared tables for chairs back to back leaves 6" to push out.
- Allow 60" between squared tables for chairs back to back leaves 26" service aisle.

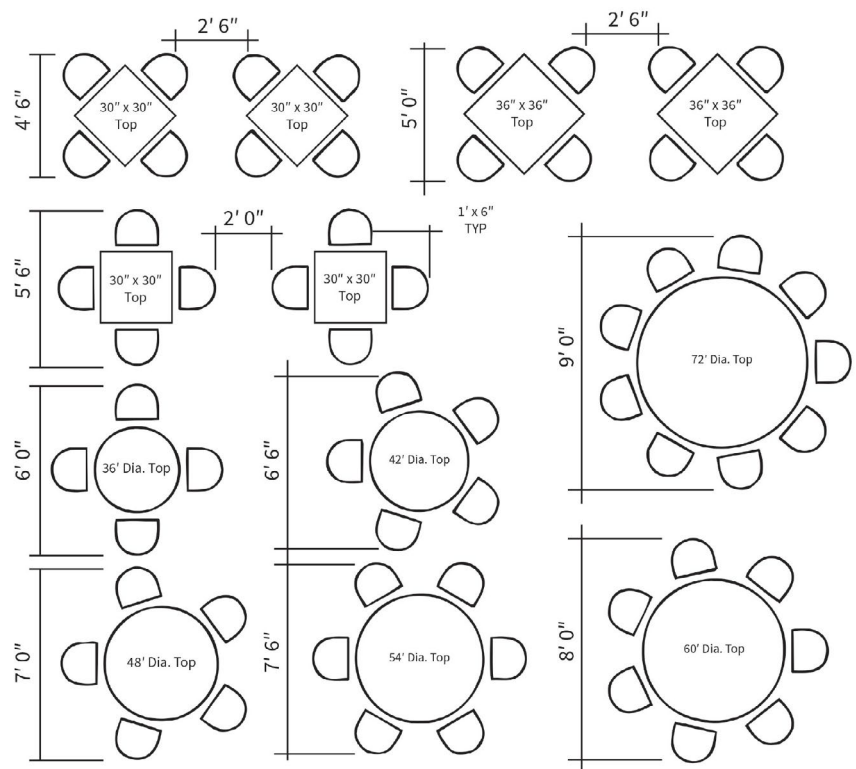

- Allow 24" between corners of diagonal tables for customer access - no aisle.
- Allow 30" between corners of diagonal tables for customer access - narrow aisle.

*\*Note: Where space is limited, booths require only 8 sq. ft. per person including aisle allowance.*

# Legends Series

\*All Legends Frames Are Painted Only



## LSC - 250

### Features

32" H x 18" W x 18" D  
18" Seat Height  
1 1/4" Pulled Seat  
1 1/4" Sq. Steel Tubing (16 Gauge)  
#18 Butyrate Heavy Duty Glide

### Optional:

3/4" Wood Seat (Add 98.81 Grade 1)

Quantity	Grade 1	Grade 2	Grade 3	Grade 4	Grade 5
100+	242.61	248.46	254.33	260.18	266.00
50 - 99	248.46	254.33	260.18	266.00	271.86
11 - 49	254.33	260.18	266.00	271.86	277.72
1 - 10	322.68	329.12	335.57	341.99	348.42

COM Yardage: 1/2 yd. - price @ GR 1  
Items Per Carton: 2

Weight: 19 lbs, Wood 21 lbs  
Shipping Class: 175



## LSC - 1250 BS

### Features

41" H x 18" W x 18" D  
30" Seat Height  
1 1/4" Pulled Seat  
1 1/4" Sq. Steel Tubing (16 Gauge)  
#18 Butyrate Heavy Duty Glide

### Optional:

3/4" Wood Seat (Add 98.81 Grade 1)  
24" Seat Height (Add 33.15)

Quantity	Grade 1	Grade 2	Grade 3	Grade 4	Grade 5
7+	315.63	321.48	327.32	333.17	339.03
1 - 6	390.12	396.54	403.00	409.43	415.85

COM Yardage: 1/2 yd. - price @ GR 1  
Items Per Carton: 1

Weight: 25 lbs, Wood 27 lbs  
Shipping Class: 175



## 600 - LSC - 250 BS

### Features

41" H x 17" W x 18" D  
1 1/4" Pulled Seat  
1 1/4" Sq. Steel Tubing (16 Gauge)  
#18 Butyrate Heavy Duty Glide  
#20 DBL Plate Swivel

### Optional:

3/4" Wood Seat (Add 98.81 Grade 1)  
24" or 30" Seat Height

Quantity	Grade 1	Grade 2	Grade 3	Grade 4	Grade 5
7+	520.67	526.49	532.35	538.20	544.05
1 - 6	615.76	622.19	628.63	635.07	641.49

COM Yardage: 1/2 yd. - price @ GR 1  
Items Per Carton: 1

Weight: 30 lbs, Wood 32 lbs  
Shipping Class: 175



## 1800 - LSC - 250 BS

### Features

41" H x 17" W x 18" D  
1 1/4" Pulled Seat  
3" Sq. Column w/ Cast Iron Bottom  
#22 DBL Plate Seat Return Swivel

### Optional:

3/4" Wood Seat (Add 98.81 Grade 1)  
18", 24", or 30" Seat Height  
Paint Only Footrest (Shown is 606: Add 157.97)

Quantity	Grade 1	Grade 2	Grade 3	Grade 4	Grade 5
7+	558.24	564.09	569.93	575.79	581.63
1 - 6	657.00	663.42	669.79	676.30	682.73

COM Yardage: 1/2 yd. - price @ GR 1  
Items Per Carton: Varies

Weight: 36 lbs, Wood 38 lbs  
Specify Floor Attachment:  
Type B (Wood)  
Type C (Concrete)

\*Footrest not available on 18"

# Vertical Ladder Back

\*All Legends Frames Are Painted Only



\*Shown with optional wood seat

## LSC - 350

### Features

32" H x 18" W x 18" D  
18" Seat Height  
1 1/4" Pulled Seat  
1 1/4" Sq. Steel Tubing (16 Gauge)  
#18 Butyrate Heavy Duty Glide

### Optional:

3/4" Wood Seat (Add 98.81 Grade 1)

Quantity	Grade 1	Grade 2	Grade 3	Grade 4	Grade 5
100+	244.57	250.43	256.26	262.11	267.97
50 - 99	250.43	256.26	262.11	267.97	273.83
11 - 49	256.26	262.11	267.97	273.83	279.65
1 - 10	324.84	331.26	337.69	344.13	350.56

COM Yardage: 1/2 yd. - price @ GR 1

Items Per Carton: 2

Weight: 18 lbs, Wood 20 lbs

Shipping Class: 175



## LSC - 1350 BS

### Features

41" H x 18" W x 18" D  
30" Seat Height  
1 1/4" Pulled Seat  
1 1/4" Sq. Steel Tubing (16 Gauge)  
#18 Butyrate Heavy Duty Glide

### Optional:

3/4" Wood Seat (Add 98.81 Grade 1)

24" Seat Height (Add 33.15)

Quantity	Grade 1	Grade 2	Grade 3	Grade 4	Grade 5
7+	344.63	350.48	356.31	362.18	368.02
1 - 6	422.02	428.45	434.91	441.33	447.76

COM Yardage: 1/2 yd. - price @ GR 1

Items Per Carton: 1

Weight: 25 lbs, Wood 27 lbs

Shipping Class: 175



## 600 - LSC - 350 BS

### Features

41" H x 17" W x 18" D  
1 1/4" Pulled Seat  
1 1/4" Sq. Steel Tubing (16 Gauge)  
#18 Butyrate Heavy Duty Glide  
#20 DBL Plate Swivel

### Optional:

3/4" Wood Seat (Add 98.81 Grade 1)

24" or 30" Seat Height

Quantity	Grade 1	Grade 2	Grade 3	Grade 4	Grade 5
7+	529.33	535.18	541.04	546.89	552.75
1 - 6	625.23	631.65	638.07	644.51	650.95

COM Yardage: 1/2 yd. - price @ GR 1

Items Per Carton: 1

Weight: 30 lbs, Wood 32 lbs

Shipping Class: 175



## 1800 - LSC - 350 BS

### Features

41" H x 17" W x 18" D  
1 1/4" Pulled Seat  
3" Sq. Column w/ Cast Iron Bottom  
#22 DBL Plate Seat Return Swivel

### Optional:

3/4" Wood Seat (Add 98.81 Grade 1)

18", 24", or 30" Seat Height

Paint Only Footrest (Shown is 606: Add 157.97)

Quantity	Grade 1	Grade 2	Grade 3	Grade 4	Grade 5
7+	566.77	572.63	578.47	584.32	590.18
1 - 6	666.40	672.82	679.25	685.69	692.14

COM Yardage: 1/2 yd. - price @ GR 1

Items Per Carton: Varies

Weight: 36 lbs, Wood 38 lbs

Specify Floor Attachment:

Type B (Wood)

Type C (Concrete)

\*Footrest not available on 18"

# Cross Strap Back

\*All Legends Frames Are Painted Only



## LSC - 450

### Features

32" H x 18" W x 18" D  
18" Seat Height  
1 1/4" Pulled Seat  
1 1/4" Sq. Steel Tubing (16 Gauge)  
#18 Butyrate Heavy Duty Glide

### Optional:

3/4" Wood Seat (Add 98.81 Grade 1)

Quantity	Grade 1	Grade 2	Grade 3	Grade 4	Grade 5
100+	251.21	257.06	262.91	268.76	274.59
50 - 99	257.06	262.91	268.76	274.59	280.46
11 - 49	262.91	268.76	274.59	280.46	286.36
1 - 10	332.12	338.56	345.00	351.43	357.85

COM Yardage: 1/2 yd. - price @ GR 1  
Items Per Carton: 2

Weight: 19lbs, Wood 21 lbs  
Shipping Class: 175



## LSC - 1450 BS

### Features

41" H x 18" W x 18" D  
30" Seat Height  
1 1/4" Pulled Seat  
1 1/4" Sq. Steel Tubing (16 Gauge)  
#18 Butyrate Heavy Duty Glide

### Optional:

3/4" Wood Seat (Add 98.81 Grade 1)  
24" Seat Height (Add 33.15)

Quantity	Grade 1	Grade 2	Grade 3	Grade 4	Grade 5
7+	341.38	347.23	353.07	358.93	364.79
1 - 6	418.46	424.89	431.31	437.74	444.20

COM Yardage: 1/2 yd. - price @ GR 1  
Items Per Carton: 1

Weight: 25lbs, Wood 27 lbs  
Shipping Class: 175

\* Shown with optional wood seat



## 600 - LSC - 450 BS

### Features

41" H x 17" W x 18" D  
1 1/4" Pulled Seat  
1 1/4" Sq. Steel Tubing (16 Gauge)  
#18 Butyrate Heavy Duty Glide  
#20 DBL Plate Swivel

### Optional:

3/4" Wood Seat (Add 98.81 Grade 1)  
24" or 30" Seat Height

Quantity	Grade 1	Grade 2	Grade 3	Grade 4	Grade 5
7+	542.18	548.04	553.89	559.72	565.58
1 - 6	639.34	645.77	652.22	658.65	665.07

COM Yardage: 1/2 yd. - price @ GR 1  
Items Per Carton: 1

Weight: 30lbs, Wood 32 lbs  
Shipping Class: 175



## 1800 - LSC - 450 BS

### Features

41" H x 17" W x 18" D  
1 1/4" Pulled Seat  
3" Sq. Column w/ Cast Iron Bottom  
#22 DBL Plate Seat Return Swivel

### Optional:

3/4" Wood Seat (Add 98.81 Grade 1)  
18", 24", or 30" Seat Height  
Paint Only Footrest (Shown is 606: Add 157.97)

Quantity	Grade 1	Grade 2	Grade 3	Grade 4	Grade 5
7+	566.77	572.63	578.47	584.32	590.18
1 - 6	666.40	672.82	679.25	685.71	692.14

COM Yardage: 1/2 yd. - price @ GR 1  
Items Per Carton: Varies

Weight: 36lbs, Wood 38 lbs  
Specify Floor Attachment:  
Type B (Wood)  
Type C (Concrete)

\*Footrest not available on 18"

# Lattice Back

\*All Legends Frames Are Painted Only



## LSC - 475

### Features

32" H x 18" W x 18" D  
18" Seat Height  
1 1/4" Pulled Seat  
1 1/4" Sq. Steel Tubing (16 Gauge)  
#18 Butyrate Heavy Duty Glide

### Optional:

3/4" Wood Seat (Add 98.81 Grade 1)

Quantity	Grade 1	Grade 2	Grade 3	Grade 4	Grade 5
100+	251.21	257.06	262.91	268.76	274.60
50 - 99	257.06	262.91	268.76	274.60	280.46
11 - 49	262.91	268.76	274.60	280.46	286.31
1 - 10	332.12	338.56	345.00	351.43	357.85

COM Yardage: 1/2 yd. - price @ GR 1  
Items Per Carton: 2

Weight: 18 lbs, Wood 20 lbs  
Shipping Class: 175



## LSC - 1475 BS

### Features

41" H x 18" W x 18" D  
30" Seat Height  
1 1/4" Pulled Seat  
1 1/4" Sq. Steel Tubing (16 Gauge)  
#18 Butyrate Heavy Duty Glide

### Optional:

3/4" Wood Seat (Add 98.81 Grade 1)  
24" Seat Height (Add 33.15)

Quantity	Grade 1	Grade 2	Grade 3	Grade 4	Grade 5
7+	341.38	347.23	353.07	358.93	364.79
1 - 6	418.46	424.89	431.31	437.74	444.23

COM Yardage: 1/2 yd. - price @ GR 1  
Items Per Carton: 1

Weight: 25 lbs, Wood 27 lbs  
Shipping Class: 175



## 600 - LSC - 475 BS

### Features

41" H x 17" W x 18" D  
1 1/4" Pulled Seat  
1 1/4" Sq. Steel Tubing (16 Gauge)  
#18 Butyrate Heavy Duty Glide  
#20 DBL Plate Swivel

### Optional:

3/4" Wood Seat (Add 98.81 Grade 1)  
24" or 30" Seat Height

Quantity	Grade 1	Grade 2	Grade 3	Grade 4	Grade 5
7+	542.18	548.04	553.89	559.72	565.58
1 - 6	639.34	645.77	652.22	658.65	665.07

COM Yardage: 1/2 yd. - price @ GR 1  
Items Per Carton: 1

Weight: 30 lbs, Wood 32 lbs  
Shipping Class: 175



## 1800 - LSC - 475 BS

### Features

41" H x 17" W x 18" D  
1 1/4" Pulled Seat  
3" Sq. Column w/ Cast Iron Bottom  
#22 DBL Plate Seat Return Swivel

### Optional:

3/4" Wood Seat (Add 98.81 Grade 1)  
18", 24", or 30" Seat Height  
Paint Only Footrest (Shown on pg. 102)

Quantity	Grade 1	Grade 2	Grade 3	Grade 4	Grade 5
7+	566.77	572.63	578.47	584.32	590.18
1 - 6	666.40	672.82	679.25	685.71	692.14

COM Yardage: 1/2 yd. - price @ GR 1  
Items Per Carton: Varies

Weight: 36 lbs, Wood 38 lbs  
Specify Floor Attachment:  
Type B (Wood)  
Type C (Concrete)

\*Footrest not available on 18"

# Slotted Moon Back

\*All Legends Frames Are Painted Only \*All Shown With Optional Wood Seat



## LSC-501

### Features

32" H x 18" W x 18" D  
18" Seat Height  
1 1/4" Pulled Seat  
1 1/4" Sq. Steel Tubing (16 Gauge)  
#18 Butyrate Heavy Duty Glide

### Optional:

3/4" Wood Seat (Add 98.81 Grade 1)

Quantity	Grade 1	Grade 2	Grade 3	Grade 4	Grade 5
100+	294.14	300.00	305.83	311.68	317.55
50 - 99	300.00	305.83	311.68	317.55	323.39
11 - 49	305.83	311.68	317.55	323.39	329.22
1 - 10	379.36	385.80	392.24	398.66	405.09

COM Yardage: 1/2 yd. - price @ GR 1  
Items Per Carton: 2

Weight: 18 lbs, Wood 20 lbs  
Shipping Class: 175



## LSC-1501 BS

### Features

41" H x 18" W x 18" D  
30" Seat Height  
1 1/4" Pulled Seat  
1 1/4" Sq. Steel Tubing (16 Gauge)  
#18 Butyrate Heavy Duty Glide

### Optional:

3/4" Wood Seat (Add 98.81 Grade 1)  
24" Seat Height (Add 33.15)

Quantity	Grade 1	Grade 2	Grade 3	Grade 4	Grade 5
7+	378.11	383.97	389.80	395.65	401.51
1 - 6	458.85	465.29	471.73	478.16	484.60

COM Yardage: 1/2 yd. - price @ GR 1  
Items Per Carton: 1

Weight: 25 lbs, Wood 27 lbs  
Shipping Class: 175



## 600-LSC-501 BS

### Features

41" H x 17" W x 18" D  
1 1/4" Pulled Seat  
1 1/4" Sq. Steel Tubing (16 Gauge)  
#18 Butyrate Heavy Duty Glide  
#20 DBL Plate Swivel

### Optional:

3/4" Wood Seat (Add 98.81 Grade 1)  
24" or 30" Seat Height

Quantity	Grade 1	Grade 2	Grade 3	Grade 4	Grade 5
7+	563.67	569.52	575.36	581.22	587.06
1 - 6	662.97	669.40	675.84	682.28	688.70

COM Yardage: 1/2 yd. - price @ GR 1  
Items Per Carton: 1

Weight: 30 lbs, Wood 32 lbs  
Shipping Class: 175



## 1800-LSC-501 BS

### Features

41" H x 17" W x 18" D  
1 1/4" Pulled Seat  
3" Sq. Column w/ Cast Iron Bottom  
#22 DBL Plate Seat Return Swivel

### Optional:

3/4" Wood Seat (Add 98.81 Grade 1)  
18", 24", or 30" Seat Height  
Paint Only Footrest (Shown is 606: Add 157.97)

Quantity	Grade 1	Grade 2	Grade 3	Grade 4	Grade 5
7+	609.76	615.60	621.46	627.31	633.16
1 - 6	713.67	720.12	726.55	732.98	739.43

COM Yardage: 1/2 yd. - price @ GR 1  
Items Per Carton: Varies

Weight: 36 lbs, Wood 38 lbs  
Specify Floor Attachment:  
Type B (Wood)  
Type C (Concrete)

\*Footrest not available on 18"

# Wooden Moon Back

\*All Legends Frames Are Painted Only



\*Shown with optional wood seat

## LSC - 550

### Features

32" H x 18" W x 18" D  
18" Seat Height  
1 1/4" Pulled Seat  
1 1/4" Sq. Steel Tubing (16 Gauge)  
#18 Butyrate Heavy Duty Glide

### Optional:

3/4" Wood Seat (Add 98.81 Grade 1)

Quantity	Grade 1	Grade 2	Grade 3	Grade 4	Grade 5
100+	294.14	300.00	305.83	311.68	317.55
50 - 99	300.00	305.83	311.68	317.55	323.39
11 - 49	305.83	311.68	317.55	323.39	329.22
1 - 10	379.36	385.80	392.24	398.66	405.09

COM Yardage: 1/2 yd. - price @ GR 1  
Items Per Carton: 2

Weight: 19 lbs, Wood 21 lbs  
Shipping Class: 175



\*Shown with optional wood seat

## LSC - 1550 BS

### Features

41" H x 18" W x 18" D  
30" Seat Height  
1 1/4" Pulled Seat  
1 1/4" Sq. Steel Tubing (16 Gauge)  
#18 Butyrate Heavy Duty Glide

### Optional:

3/4" Wood Seat (Add 98.81 Grade 1)  
24" Seat Height (Add 33.15)

Quantity	Grade 1	Grade 2	Grade 3	Grade 4	Grade 5
7+	378.11	383.97	389.80	395.65	401.51
1 - 6	458.85	465.29	471.73	478.16	484.60

COM Yardage: 1/2 yd. - price @ GR 1  
Items Per Carton: 1

Weight: 25 lbs, Wood 27 lbs  
Shipping Class: 175



## 600 - LSC - 550 BS

### Features

41" H x 17" W x 18" D  
1 1/4" Pulled Seat  
1 1/4" Sq. Steel Tubing (16 Gauge)  
#18 Butyrate Heavy Duty Glide  
#20 DBL Plate Swivel

### Optional:

3/4" Wood Seat (Add 98.81 Grade 1)  
24" or 30" Seat Height

Quantity	Grade 1	Grade 2	Grade 3	Grade 4	Grade 5
7+	563.67	569.52	575.36	581.22	587.06
1 - 6	662.97	669.40	675.84	682.28	688.70

COM Yardage: 1/2 yd. - price @ GR 1  
Items Per Carton: 1

Weight: 30 lbs, Wood 32 lbs  
Shipping Class: 175



## 1800 - LSC - 550 BS

### Features

41" H x 17" W x 18" D  
1 1/4" Pulled Seat  
3" Sq. Column w/ Cast Iron Bottom  
#22 DBL Plate Seat Return Swivel

### Optional:

3/4" Wood Seat (Add 98.81 Grade 1)  
18", 24", or 30" Seat Height  
Paint Only Footrest (Shown is 606: Add 157.97)

Quantity	Grade 1	Grade 2	Grade 3	Grade 4	Grade 5
7+	609.76	615.60	621.46	627.31	633.16
1 - 6	713.67	720.12	726.55	732.98	739.43

COM Yardage: 1/2 yd. - price @ GR 1  
Items Per Carton: Varies

Weight: 36 lbs, Wood 38 lbs  
Specify Floor Attachment:  
Type B (Wood)  
Type C (Concrete)

\*Footrest not available on 18"

# Three Slotted Wood Back

\*All Legends Frames Are Painted Only



\* Shown with optional wood seat

## LSC - 575

### Features

32" H x 18" W x 18" D  
18" Seat Height  
1 1/4" Pulled Seat  
1 1/4" Sq. Steel Tubing (16 Gauge)  
#18 Butyrate Heavy Duty Glide

### Optional:

3/4" Wood Seat (Add 98.81 Grade 1)

Quantity	Grade 1	Grade 2	Grade 3	Grade 4	Grade 5
100+	294.14	300.00	305.83	311.68	317.55
50 - 99	300.00	305.83	311.68	317.55	323.39
11 - 49	305.83	311.68	317.55	323.39	329.22
1 - 10	379.36	385.80	392.24	398.66	405.09

COM Yardage: 1/2 yd. - price @ GR 1  
Items Per Carton: 2

Weight: 19lbs, Wood 21 lbs  
Shipping Class: 175



\* Shown with optional wood seat

## LSC - 1575 BS

### Features

41" H x 18" W x 18" D  
30" Seat Height  
1 1/4" Pulled Seat  
1 1/4" Sq. Steel Tubing (16 Gauge)  
#18 Butyrate Heavy Duty Glide

### Optional:

3/4" Wood Seat (Add 98.81 Grade 1)  
24" Seat Height (Add 33.15)

Quantity	Grade 1	Grade 2	Grade 3	Grade 4	Grade 5
7+	378.11	383.97	389.80	395.65	401.51
1 - 6	458.85	465.29	471.73	478.16	484.60

COM Yardage: 1/2 yd. - price @ GR 1  
Items Per Carton: 1

Weight: 25lbs, Wood 27 lbs  
Shipping Class: 175



## 600 - LSC - 575 BS

### Features

41" H x 17" W x 18" D  
1 1/4" Pulled Seat  
1 1/4" Sq. Steel Tubing (16 Gauge)  
#18 Butyrate Heavy Duty Glide  
#20 DBL Plate Swivel

### Optional:

3/4" Wood Seat (Add 98.81 Grade 1)  
24" or 30" Seat Height

Quantity	Grade 1	Grade 2	Grade 3	Grade 4	Grade 5
7+	563.67	569.52	575.36	581.22	587.06
1 - 6	662.97	669.40	675.84	682.28	688.70

COM Yardage: 1/2 yd. - price @ GR 1  
Items Per Carton: 1

Weight: 30lbs, Wood 32 lbs  
Shipping Class: 175



## 1800 - LSC - 575 BS

### Features

41" H x 17" W x 18" D  
1 1/4" Pulled Seat  
3" Sq. Column w/ Cast Iron Bottom  
#22 DBL Plate Seat Return Swivel

### Optional:

3/4" Wood Seat (Add 98.81 Grade 1)  
18", 24", or 30" Seat Height  
Paint Only Footrest (Shown is 606: Add 157.97)

Quantity	Grade 1	Grade 2	Grade 3	Grade 4	Grade 5
7+	609.76	615.60	621.46	627.31	633.16
1 - 6	713.67	720.12	726.55	732.98	739.43

COM Yardage: 1/2 yd. - price @ GR 1  
Items Per Carton: Varies

Weight: 36lbs, Wood 38 lbs  
Specify Floor Attachment:  
Type B (Wood)  
Type C (Concrete)

\*Footrest not available on 18"

# Five Slotted Wood Back

\*All Legends Frames Are Painted Only



## LSC - 600

### Features

32" H x 18" W x 18" D  
18" Seat Height  
1 1/4" Pulled Seat  
1 1/4" Sq. Steel Tubing (16 Gauge)  
#18 Butyrate Heavy Duty Glide

### Optional:

3/4" Wood Seat (Add 98.81 Grade 1)

Quantity	Grade 1	Grade 2	Grade 3	Grade 4	Grade 5
100+	294.14	300.00	305.83	311.68	317.55
50 - 99	300.00	305.83	311.68	317.55	323.39
11 - 49	305.83	311.68	317.55	323.39	329.22
1 - 10	379.36	385.80	392.24	398.66	405.09

COM Yardage: 1/2 yd. - price @ GR 1  
Items Per Carton: 2

Weight: 19 lbs, Wood 21 lbs  
Shipping Class: 175



## LSC - 1600 BS

### Features

41" H x 18" W x 18" D  
30" Seat Height  
1 1/4" Pulled Seat  
1 1/4" Sq. Steel Tubing (16 Gauge)  
#18 Butyrate Heavy Duty Glide

### Optional:

3/4" Wood Seat (Add 98.81 Grade 1)  
24" Seat Height (Add 33.15)

Quantity	Grade 1	Grade 2	Grade 3	Grade 4	Grade 5
7+	378.11	383.97	389.80	395.65	401.51
1 - 6	458.85	465.29	471.73	478.16	484.60

COM Yardage: 1/2 yd. - price @ GR 1  
Items Per Carton: 1

Weight: 25 lbs, Wood 27 lbs  
Shipping Class: 175



## 600 - LSC - 600 BS

### Features

41" H x 17" W x 18" D  
1 1/4" Pulled Seat  
1 1/4" Sq. Steel Tubing (16 Gauge)  
#18 Butyrate Heavy Duty Glide  
#20 DBL Plate Swivel

### Optional:

3/4" Wood Seat (Add 98.81 Grade 1)  
24" or 30" Seat Height

Quantity	Grade 1	Grade 2	Grade 3	Grade 4	Grade 5
7+	563.67	569.52	575.36	581.22	587.06
1 - 6	662.97	669.40	675.84	682.28	688.70

COM Yardage: 1/2 yd. - price @ GR 1  
Items Per Carton: 1

Weight: 30 lbs, Wood 32 lbs  
Shipping Class: 175



## 1800 - LSC - 600 BS

### Features

41" H x 17" W x 18" D  
1 1/4" Pulled Seat  
3" Sq. Column w/ Cast Iron Bottom  
#22 DBL Plate Seat Return Swivel

### Optional:

3/4" Wood Seat (Add 98.81 Grade 1)  
18", 24", or 30" Seat Height  
Paint Only Footrest (Shown is 606: Add 157.97)

Quantity	Grade 1	Grade 2	Grade 3	Grade 4	Grade 5
7+	609.76	615.60	621.46	627.31	633.16
1 - 6	713.67	720.12	726.55	732.98	739.43

COM Yardage: 1/2 yd. - price @ GR 1  
Items Per Carton: Varies

Weight: 36 lbs, Wood 38 lbs  
Specify Floor Attachment:  
Type B (Wood)  
Type C (Concrete)

\*Footrest not available on 18"

# Four Rung Ladder Back

\*All Legends Frames Are Painted Only



## LSC - 650

### Features

32" H x 18" W x 18" D  
18" Seat Height  
1 1/4" Pulled Seat  
1 1/4" Sq. Steel Tubing (16 Gauge)  
#18 Butyrate Heavy Duty Glide

### Optional:

3/4" Wood Seat (Add 98.81 Grade 1)

Quantity	Grade 1	Grade 2	Grade 3	Grade 4	Grade 5
100+	260.49	266.35	272.21	278.04	283.90
50 - 99	266.35	272.21	278.04	283.90	289.74
11 - 49	272.21	278.04	283.90	289.74	295.60
1 - 10	342.37	348.79	355.21	361.68	368.10

COM Yardage: 1/2 yd. - price @ GR 1  
Items Per Carton: 2

Weight: 20 lbs, Wood 22 lbs  
Shipping Class: 175



## LSC - 1650 BS

### Features

41" H x 18" W x 18" D  
30" Seat Height  
1 1/4" Pulled Seat  
1 1/4" Sq. Steel Tubing (16 Gauge)  
#18 Butyrate Heavy Duty Glide

### Optional:

3/4" Wood Seat (Add 98.81 Grade 1)  
24" Seat Height (Add 33.15)

Quantity	Grade 1	Grade 2	Grade 3	Grade 4	Grade 5
7+	324.93	330.76	336.61	342.47	348.32
1 - 6	400.35	406.78	413.20	419.66	426.08

COM Yardage: 1/2 yd. - price @ GR 1  
Items Per Carton: 1

Weight: 25 lbs, Wood 27 lbs  
Shipping Class: 175



## 600 - LSC - 650 BS

### Features

41" H x 17" W x 18" D  
1 1/4" Pulled Seat  
1 1/4" Sq. Steel Tubing (16 Gauge)  
#18 Butyrate Heavy Duty Glide  
#20 DBL Plate Swivel

### Optional:

3/4" Wood Seat (Add 98.81 Grade 1)  
24" or 30" Seat Height

Quantity	Grade 1	Grade 2	Grade 3	Grade 4	Grade 5
7+	551.47	557.33	563.17	569.03	574.88
1 - 6	649.57	655.99	662.43	668.86	675.31

COM Yardage: 1/2 yd. - price @ GR 1  
Items Per Carton: 1

Weight: 30 lbs, Wood 32 lbs  
Shipping Class: 175



## 1800 - LSC - 650 BS

### Features

41" H x 17" W x 18" D  
1 1/4" Pulled Seat  
3" Sq. Column w/ Cast Iron Bottom  
#22 DBL Plate Seat Return Swivel

### Optional:

3/4" Wood Seat (Add 98.81 Grade 1)  
18", 24", or 30" Seat Height  
Paint Only Footrest (Shown is 606: Add 157.97)

Quantity	Grade 1	Grade 2	Grade 3	Grade 4	Grade 5
7+	575.99	581.85	587.71	593.54	599.40
1 - 6	676.53	682.97	689.41	695.84	702.28

COM Yardage: 1/2 yd. - price @ GR 1  
Items Per Carton: Varies

Weight: 36 lbs, Wood 38 lbs  
Specify Floor Attachment:  
Type B (Wood)  
Type C (Concrete)

\*Footrest not available on 18"

# Three Rung Ladder Back

\*All Legends Frames Are Painted Only \*All Shown With Optional Wood Seat



## LSC - 750

### Features

32" H x 18" W x 18" D  
18" Seat Height  
1 1/4" Pulled Seat  
1 1/4" Sq. Steel Tubing (16 Gauge)  
#18 Butyrate Heavy Duty Glide

### Optional:

3/4" Wood Seat (Add 98.81 Grade 1)

Quantity	Grade 1	Grade 2	Grade 3	Grade 4	Grade 5
100+	251.90	257.75	263.61	269.45	275.31
50 - 99	257.75	263.61	269.45	275.31	281.17
11 - 49	263.61	269.45	275.31	281.17	287.00
1 - 10	332.91	339.33	345.77	352.21	358.64

COM Yardage: 1/2 yd. - price @ GR 1  
Items Per Carton: 2

Weight: 19 lbs, Wood 21 lbs  
Shipping Class: 175



## LSC - 1750 BS

### Features

41" H x 18" W x 18" D  
30" Seat Height  
1 1/4" Pulled Seat  
1 1/4" Sq. Steel Tubing (16 Gauge)  
#18 Butyrate Heavy Duty Glide

### Optional:

3/4" Wood Seat (Add 98.81 Grade 1)  
24" Seat Height (Add 33.15)

Quantity	Grade 1	Grade 2	Grade 3	Grade 4	Grade 5
7+	316.34	322.16	328.02	333.88	339.73
1 - 6	390.89	397.31	403.78	410.20	416.62

COM Yardage: 1/2 yd. - price @ GR 1  
Items Per Carton: 1

Weight: 25 lbs, Wood 27 lbs  
Shipping Class: 175



## 600 - LSC - 750 BS

### Features

41" H x 17" W x 18" D  
1 1/4" Pulled Seat  
1 1/4" Sq. Steel Tubing (16 Gauge)  
#18 Butyrate Heavy Duty Glide  
#20 DBL Plate Swivel

### Optional:

3/4" Wood Seat (Add 98.81 Grade 1)  
24" or 30" Seat Height

Quantity	Grade 1	Grade 2	Grade 3	Grade 4	Grade 5
7+	533.61	539.46	545.31	551.16	557.02
1 - 6	629.91	636.34	642.77	649.21	655.64

COM Yardage: 1/2 yd. - price @ GR 1  
Items Per Carton: 1

Weight: 30 lbs, Wood 32 lbs  
Shipping Class: 175



## 1800 - LSC - 750 BS

### Features

41" H x 17" W x 18" D  
1 1/4" Pulled Seat  
3" Sq. Column w/ Cast Iron Bottom  
#22 DBL Plate Seat Return Swivel

### Optional:

3/4" Wood Seat (Add 98.81 Grade 1)  
18", 24", or 30" Seat Height  
Paint Only Footrest (Shown is 606: Add 157.97)

Quantity	Grade 1	Grade 2	Grade 3	Grade 4	Grade 5
7+	567.21	573.07	578.92	584.75	590.61
1 - 6	666.87	673.30	679.75	686.18	692.61

COM Yardage: 1/2 yd. - price @ GR 1  
Items Per Carton: Varies

Weight: 36 lbs, Wood 38 lbs  
Specify Floor Attachment:  
Type B (Wood)  
Type C (Concrete)

\*Footrest not available on 18"

# Oxford Series

\*All Oxford Frames Are Painted Only

\*¾" Wood Seat (Add 98.81)



## OX - 10

### Features

34" H x 17" W x 18" D  
18" Seat Height  
1¼" Pulled Seat  
1¼" Sq. Steel Tubing (16 Gauge)  
Contoured Back w/ Button  
#18 Butyrate Heavy Duty Glide

Quantity	Grade 1	Grade 2	Grade 3	Grade 4	Grade 5
100+	362.86	368.71	374.55	380.40	386.27
50 - 99	368.71	374.55	380.40	386.27	392.10
11 - 49	374.55	380.40	386.27	392.10	397.94
1 - 10	454.94	461.37	467.82	474.25	480.70

COM Yardage: 1⅓ yds. - price @ GR 1  
Items Per Carton: 2

Weight: 21 lbs, Wood 23 lbs  
Shipping Class: 175



## OX - 110 BS

### Features

44" H x 17" W x 18" D  
30" Seat Height  
1¼" Pulled Seat  
1¼" Sq. Steel Tubing (16 Gauge)  
Contoured Back w/ Button  
#18 Butyrate Heavy Duty Glide

Quantity	Grade 1	Grade 2	Grade 3	Grade 4	Grade 5
7+	448.72	454.58	460.44	466.26	472.12
1 - 6	536.55	542.97	549.40	555.85	562.28

COM Yardage: 1⅓ yds. - price @ GR 1  
Items Per Carton: 1

Weight: 30 lbs, Wood 32 lbs  
Shipping Class: 175

### Optional:

24" Seat Height (Add 33.51)



## 600 - OX - 10 BS

### Features

44" H x 17" W x 18" D  
1¼" Pulled Seat  
1¼" Sq. Steel Tubing (16 Gauge)  
Contoured Back w/ Button  
#18 Butyrate Heavy Duty Glide  
#20 DBL Plate Swivel

Quantity	Grade 1	Grade 2	Grade 3	Grade 4	Grade 5
7+	637.64	643.49	649.34	655.20	661.03
1 - 6	744.33	750.77	757.20	763.64	770.08

COM Yardage: 1⅓ yds. - price @ GR 1  
Items Per Carton: 1

Weight: 30 lbs, Wood 32 lbs  
Shipping Class: 175

### Optional:

24" or 30" Seat Height



## 1800 - OX - 10 BS

### Features

44" H x 17" W x 18" D  
1¼" Pulled Seat  
3" Sq. Column w/ Cast Iron Bottom  
#22 DBL Plate Seat Return Swivel

Quantity	Grade 1	Grade 2	Grade 3	Grade 4	Grade 5
7+	680.57	686.44	692.27	698.11	703.97
1 - 6	791.56	798.01	804.44	810.87	817.32

COM Yardage: 1⅓ yds. - price @ GR 1  
Items Per Carton: Varies

Weight: 36 lbs, Wood 38 lbs  
Specify Floor Attachment:  
Type B (Wood)  
Type C (Concrete)

### Optional:

18", 24", or 30" Seat Height  
Paint Only Footrest (Shown is 606: Add 157.97)

\*Footrest not available on 18"

# Round Back

\*All Oxford Frames Are Painted Only

\*¾" Wood Seat (Add 98.81)



## OX - 20

### Features

35" H x 17" W x 18" D  
18" Seat Height  
1¼" Pulled Seat  
1¼" Sq. Steel Tubing (16 Gauge)  
Contoured Back  
#18 Butyrate Heavy Duty Glide

Quantity	Grade 1	Grade 2	Grade 3	Grade 4	Grade 5
100+	362.86	368.71	374.55	380.40	386.27
50 - 99	368.71	374.55	380.40	386.27	392.10
11 - 49	374.55	380.40	386.27	392.10	397.94
1 - 10	454.94	461.37	467.82	474.25	480.70

COM Yardage: 1½ yds. - price @ GR 1  
Items Per Carton: 2

Weight: 21 lbs, Wood 23 lbs  
Shipping Class: 175



## OX - 120 BS

### Features

45" H x 17" W x 18" D  
30" Seat Height  
1¼" Pulled Seat  
1¼" Sq. Steel Tubing (16 Gauge)  
Contoured Back  
#18 Butyrate Heavy Duty Glide

Quantity	Grade 1	Grade 2	Grade 3	Grade 4	Grade 5
7+	448.72	454.58	460.44	466.26	472.12
1 - 6	536.55	542.97	549.40	555.85	562.28

COM Yardage: 1½ yds. - price @ GR 1  
Items Per Carton: 1

Weight: 30 lbs, Wood 32 lbs  
Shipping Class: 175

### Optional:

24" Seat Height (Add 33.15)



## 600 - OX - 20 BS

### Features

45" H x 17" W x 18" D  
1¼" Pulled Seat  
1¼" Sq. Steel Tubing (16 Gauge)  
Contoured Back  
#18 Butyrate Heavy Duty Glide  
#20 DBL Plate Swivel

Quantity	Grade 1	Grade 2	Grade 3	Grade 4	Grade 5
7+	637.64	643.49	649.34	655.20	661.03
1 - 6	744.33	750.77	757.20	763.64	770.08

COM Yardage: 1½ yds. - price @ GR 1  
Items Per Carton: 1

Weight: 30 lbs, Wood 32 lbs  
Shipping Class: 175

### Optional:

24" or 30" Seat Height



## 1800 - OX - 20 BS

### Features

45" H x 17" W x 18" D  
1¼" Pulled Seat  
3" Sq. Column w/ Cast Iron Bottom  
#22 DBL Plate Seat Return Swivel

Quantity	Grade 1	Grade 2	Grade 3	Grade 4	Grade 5
7+	680.57	686.44	692.27	698.11	703.97
1 - 6	791.56	798.01	804.44	810.87	817.32

COM Yardage: 1½ yds. - price @ GR 1  
Items Per Carton: Varies

Weight: 36 lbs, Wood 38 lbs  
Specify Floor Attachment:  
Type B (Wood)  
Type C (Concrete)

### Optional:

18", 24", or 30" Seat Height  
Paint Only Footrest (Shown is 606: Add 157.97)

\*Footrest not available on 18"

# Channel Back

\*All Oxford Frames Are Painted Only

\*¾" Wood Seat (Add 98.81)



## OX - 30

### Features

34" H x 17" W x 18" D  
18" Seat Height  
1¼" Pulled Seat  
1¼" Sq. Steel Tubing (16 Gauge)  
Contoured Back w/ Channels  
#18 Butyrate Heavy Duty Glide

Quantity	Grade 1	Grade 2	Grade 3	Grade 4	Grade 5
100+	362.86	368.71	374.55	380.40	386.27
50 – 99	368.71	374.55	380.40	386.27	392.10
11 – 49	374.55	380.40	386.27	392.10	397.94
1 – 10	454.94	461.37	467.82	474.25	480.70

COM Yardage: 1⅓ yds. - price @ GR 1  
Items Per Carton: 2

Weight: 21 lbs, Wood 23 lbs  
Shipping Class: 175



## OX - 130 BS

### Features

44" H x 17" W x 18" D  
30" Seat Height  
1¼" Pulled Seat  
1¼" Sq. Steel Tubing (16 Gauge)  
Contoured Back w/ Channels  
#18 Butyrate Heavy Duty Glide

Quantity	Grade 1	Grade 2	Grade 3	Grade 4	Grade 5
7+	448.72	454.58	460.44	466.26	472.12
1 – 6	536.55	542.97	549.40	555.85	562.28

COM Yardage: 1⅓ yds. - price @ GR 1  
Items Per Carton: 1

Weight: 30 lbs, Wood 32 lbs  
Shipping Class: 175

### Optional:

24" Seat Height (Add 33.15)



## 600 - OX - 30 BS

### Features

44" H x 17" W x 18" D  
1¼" Pulled Seat  
1¼" Sq. Steel Tubing (16 Gauge)  
Contoured Back w/ Channels  
#18 Butyrate Heavy Duty Glide  
#20 DBL Plate Swivel

Quantity	Grade 1	Grade 2	Grade 3	Grade 4	Grade 5
7+	637.64	643.49	649.34	655.20	661.03
1 – 6	744.33	750.77	757.20	763.64	770.08

COM Yardage: 1⅓ yds. - price @ GR 1  
Items Per Carton: 1

Weight: 30 lbs, Wood 32 lbs  
Shipping Class: 175

### Optional:

24" or 30" Seat Height



## 1800 - OX - 30 BS

### Features

44" H x 17" W x 18" D  
1¼" Pulled Seat  
3" Sq. Column w/ Cast Iron Bottom  
#22 DBL Plate Seat Return Swivel

Quantity	Grade 1	Grade 2	Grade 3	Grade 4	Grade 5
7+	680.57	686.44	692.27	698.11	703.97
1 – 6	791.56	798.01	804.44	810.87	817.32

COM Yardage: 1⅓ yds. - price @ GR 1  
Items Per Carton: Varies

Weight: 36 lbs, Wood 38 lbs  
Specify Floor Attachment:  
Type B (Wood)  
Type C (Concrete)

### Optional:

18", 24", or 30" Seat Height  
Paint Only Footrest (Shown on pg. 104)  
(Add 157.97)

\*Footrest not available on 18"

# Banana Back

\*All Oxford Frames Are Painted Only

\*¾" Wood Seat (Add 98.81)



## OX - 40

### Features

33" H x 17" W x 18" D  
18" Seat Height  
1¼" Pulled Seat  
1¼" Sq. Steel Tubing (16 Gauge)  
Contoured Back  
#18 Butyrate Heavy Duty Glide

Quantity	Grade 1	Grade 2	Grade 3	Grade 4	Grade 5
100+	291.99	297.85	303.70	309.55	315.39
50 - 99	297.85	303.70	309.55	315.39	321.24
11 - 49	303.70	309.55	315.39	321.24	327.10
1 - 10	376.99	383.44	389.88	396.30	402.74

COM Yardage: 1½ yds. - price @ GR 1  
Items Per Carton: 2

Weight: 21 lbs, Wood 23 lbs  
Shipping Class: 175



## OX - 140 BS

### Features

43" H x 17" W x 18" D  
30" Seat Height  
1¼" Pulled Seat  
1¼" Sq. Steel Tubing (16 Gauge)  
Contoured Back  
#18 Butyrate Heavy Duty Glide

Quantity	Grade 1	Grade 2	Grade 3	Grade 4	Grade 5
7+	369.28	375.15	380.99	386.83	392.68
1 - 6	449.15	455.60	462.02	468.45	474.91

COM Yardage: 1½ yds. - price @ GR 1  
Items Per Carton: 1

Weight: 30 lbs, Wood 32 lbs  
Shipping Class: 175

### Optional:

24" Seat Height (Add 33.15)



## 600 - OX - 40 BS

### Features

43" H x 17" W x 18" D  
1¼" Pulled Seat  
1¼" Sq. Steel Tubing (16 Gauge)  
Contoured Back  
#18 Butyrate Heavy Duty Glide  
#20 DBL Plate Swivel

Quantity	Grade 1	Grade 2	Grade 3	Grade 4	Grade 5
7+	560.35	566.21	572.02	577.91	583.74
1 - 6	659.32	665.74	672.19	678.63	685.05

COM Yardage: 1½ yds. - price @ GR 1  
Items Per Carton: 1

Weight: 30 lbs, Wood 32 lbs  
Shipping Class: 175

### Optional:

24" or 30" Seat Height



## 1800 - OX - 40 BS

### Features

43" H x 17" W x 18" D  
1¼" Pulled Seat  
3" Sq. Column w/ Cast Iron Bottom  
#22 DBL Plate Seat Return Swivel

Quantity	Grade 1	Grade 2	Grade 3	Grade 4	Grade 5
7+	603.29	609.13	614.97	620.83	626.68
1 - 6	706.53	712.99	719.41	725.84	732.30

COM Yardage: 1½ yds. - price @ GR 1  
Items Per Carton: Varies

Weight: 36 lbs, Wood 38 lbs  
Specify Floor Attachment:  
Type B (Wood)  
Type C (Concrete)

### Optional:

18", 24", or 30" Seat Height  
Paint Only Footrest (Shown on pg. 104)  
(Add 157.97)

\*Footrest not available on 18"

# Sled Back

\*All Oxford Frames Are Painted Only

\*¾" Wood Seat (Add 98.82)



## OX - 50

### Features

33" H x 17" W x 18" D  
18" Seat Height  
1¼" Pulled Seat  
1¼" Sq. Steel Tubing (16 Gauge)  
Contoured Back  
#18 Butyrate Heavy Duty Glide

Quantity	Grade 1	Grade 2	Grade 3	Grade 4	Grade 5
100+	291.99	297.85	303.70	309.55	315.39
50 - 99	297.85	303.70	309.55	315.39	321.24
11 - 49	303.70	309.55	315.39	321.24	327.10
1 - 10	376.99	383.44	389.88	396.30	402.74

COM Yardage: 1⅓ yds. - price @ GR 1  
Items Per Carton: 2

Weight: 21 lbs, Wood 23 lbs  
Shipping Class: 175



## OX - 150 BS

### Features

43" H x 17" W x 18" D  
30" Seat Height  
1¼" Pulled Seat  
1¼" Sq. Steel Tubing (16 Gauge)  
Contoured Back  
#18 Butyrate Heavy Duty Glide

Quantity	Grade 1	Grade 2	Grade 3	Grade 4	Grade 5
7+	369.28	375.15	380.99	386.83	392.68
1 - 6	449.15	455.60	462.02	468.45	474.91

COM Yardage: 1⅓ yds. - price @ GR 1  
Items Per Carton: 1

Weight: 30 lbs, Wood 32 lbs  
Shipping Class: 175

### Optional:

24" Seat Height (Add 33.15)



## 600 - OX - 50 BS

### Features

43" H x 17" W x 18" D  
1¼" Pulled Seat  
1¼" Sq. Steel Tubing (16 Gauge)  
Contoured Back  
#18 Butyrate Heavy Duty Glide  
#20 DBL Plate Swivel

Quantity	Grade 1	Grade 2	Grade 3	Grade 4	Grade 5
7+	560.35	566.21	572.02	577.91	583.74
1 - 6	659.32	665.74	672.19	678.63	685.05

COM Yardage: 1⅓ yds. - price @ GR 1  
Items Per Carton: 1

Weight: 30 lbs, Wood 32 lbs  
Shipping Class: 175

### Optional:

24" or 30" Seat Height



## 1800 - OX - 50 BS

### Features

44" H x 17" W x 18" D  
1¼" Pulled Seat  
3" Sq. Column w/ Cast Iron Bottom  
#22 DBL Plate Seat Return Swivel

Quantity	Grade 1	Grade 2	Grade 3	Grade 4	Grade 5
7+	603.29	609.13	614.97	620.83	626.68
1 - 6	706.53	712.99	719.41	725.84	732.30

COM Yardage: 1⅓ yds. - price @ GR 1  
Items Per Carton: Varies

Weight: 36 lbs, Wood 38 lbs  
Specify Floor Attachment:  
Type B (Wood)  
Type C (Concrete)

### Optional:

18", 24", or 30" Seat Height  
Paint Only Footrest (Shown is 606: Add 157.97)

\*Footrest not available on 18"

# Plain Back

\*All Oxford Frames Are Painted Only

\* $\frac{3}{4}$ " Wood Seat (Add 98.82)



## OX - 60

### Features

32" H x 17" W x 18" D  
18" Seat Height  
1 $\frac{1}{4}$ " Pulled Seat  
1 $\frac{1}{4}$ " Sq. Steel Tubing (16 Gauge)  
Contoured Back  
#18 Butyrate Heavy Duty Glide

Quantity	Grade 1	Grade 2	Grade 3	Grade 4	Grade 5
100+	291.99	297.85	303.70	309.55	315.39
50 - 99	297.85	303.70	309.55	315.39	321.24
11 - 49	303.70	309.55	315.39	321.24	327.10
1 - 10	376.99	383.44	389.88	396.30	402.74

COM Yardage: 1 yd. - price @ GR 1  
Items Per Carton: 2

Weight: 21 lbs, Wood 23 lbs  
Shipping Class: 175



## OX - 160 BS

### Features

41" H x 17" W x 18" D  
30" Seat Height  
1 $\frac{1}{4}$ " Pulled Seat  
1 $\frac{1}{4}$ " Sq. Steel Tubing (16 Gauge)  
Contoured Back  
#18 Butyrate Heavy Duty Glide

Quantity	Grade 1	Grade 2	Grade 3	Grade 4	Grade 5
7+	369.28	375.15	380.99	386.83	392.68
1 - 6	449.15	455.60	462.02	468.45	474.91

COM Yardage: 1 yd. - price @ GR 1  
Items Per Carton: 1

Weight: 30 lbs, Wood 32 lbs  
Shipping Class: 175

### Optional:

24" Seat Height (Add 33.15)



## 600 - OX - 60 BS

### Features

41" H x 17" W x 18" D  
1 $\frac{1}{4}$ " Pulled Seat  
1 $\frac{1}{4}$ " Sq. Steel Tubing (16 Gauge)  
Contoured Back  
#18 Butyrate Heavy Duty Glide  
#20 DBL Plate Swivel

Quantity	Grade 1	Grade 2	Grade 3	Grade 4	Grade 5
7+	560.35	566.21	572.02	577.91	583.74
1 - 6	659.32	665.74	672.19	678.63	685.05

COM Yardage: 1 yd. - price @ GR 1  
Items Per Carton: 1

Weight: 30 lbs, Wood 32 lbs  
Shipping Class: 175

### Optional:

24" or 30" Seat Height



## 1800 - OX - 60 BS

### Features

41" H x 17" W x 18" D  
1 $\frac{1}{4}$ " Pulled Seat  
3" Sq. Column w/ Cast Iron Bottom  
#22 DBL Plate Seat Return Swivel

Quantity	Grade 1	Grade 2	Grade 3	Grade 4	Grade 5
7+	603.29	609.13	614.97	620.83	626.68
1 - 6	706.53	712.99	719.41	725.84	732.30

COM Yardage: 1 yd. - price @ GR 1  
Items Per Carton: Varies

Weight: 36 lbs, Wood 38 lbs  
Specify Floor Attachment:  
Type B (Wood)  
Type C (Concrete)

### Optional:

18", 24", or 30" Seat Height

Paint Only Footrest (Shown on pg. 104)  
(Add 157.97)

\*Footrest not available on 18"

# 1800 Series Stool Bases



## 1800 - X50 WD

### Features

30" H x 16" W x 16" D  
 Old Style Cast Iron Base  
 Standard Powder Paint  
 Wood Seat  
 #18 Swivel

### Optional:

18", 24", 30" Seat Heights  
 Type B or C Floor Attachments  
 Paint Only Footrest (Shown on pg. 104)  
 (Add 157.97)

*\*Footrest not available on 18"*

### Quantity

7+	553.37
1 - 6	650.81

Items Per Carton: 1

Weight: 30 lb

Packed Size: 15" x 15" x 30"



## 1800 - X50 WD - 606

### Features

30" H x 16" W x 16" D  
 Old Style Cast Iron Base  
 Standard Powder Paint  
 Wood Seat  
 #18 Swivel

### Optional:

24", 30" Seat Heights  
 Type B or C Floor Attachments  
 Paint Only Footrest (Shown is 606: Add 157.97)

*\*Footrest not available on 18"*

### Quantity

*\* Priced with optional 606 footrest*

7+	707.20
1 - 6	820.00

Items Per Carton: 1

Weight: 32 lb

Packed Size: 15" x 15" x 30"

## Standard Wood Finishes



Walnut

Black

Cherry

Dark Mahogany

Mahogany

Natural

*\* Finishes are reproduced as accurately as possible, colors may vary from actual product color.*

# Omni & Spectrum Series



**Stacking Channel  
Back Chair**

## SCB - PS

### Features

37" H x 20" W x 20" D  
18" Seat Height  
1½" Thick Seat  
1¼" Rd. Steel Tubing (16 Gauge)  
#15 Platform Glide  
Stacks 6 High

## Stackable Spectrum

Quantity	Grade 1	Grade 2	Grade 3	Grade 4	Grade 5
100+	314.57	320.42	326.28	332.12	337.96
50 - 99	320.42	326.28	332.12	337.96	343.82
11 - 49	326.28	332.12	337.96	343.82	349.68
1 - 10	401.86	408.28	414.70	421.12	427.59

COM Yardage: 1⅓ yds. - price @ GR 1  
Items Per Carton: 4

Weight: 25 lbs  
Shipping Class: 175



**Channel Back Stool**

## CBBS - PS

### Features

46" H x 17½" W x 20" D  
30" Seat Height  
1½" Thick Seat  
1¼" Rd. Steel Tubing (16 Gauge)  
#15 Platform Glide

### Optional:

24" Seat Height (Add 33.15)

Quantity	Grade 1	Grade 2	Grade 3	Grade 4	Grade 5
7+	409.00	414.87	420.72	426.55	432.42
1 - 6	492.86	499.28	505.71	512.14	518.59

COM Yardage: 1⅓ yds. - price @ GR 1  
Items Per Carton: 1

Weight: 31 lbs  
Shipping Class: 175



**Double Slat Chair**

## DS - PS

### Features

37" H x 17½" W x 20" D  
18" Seat Height  
1½" Thick Seat  
1¼" Rd. Steel Tubing (16 Gauge)  
#15 Platform Glide

Quantity	Grade 1	Grade 2	Grade 3	Grade 4	Grade 5
100+	227.44	233.29	239.12	244.99	250.83
50 - 99	233.29	239.12	244.99	250.83	256.68
11 - 49	239.12	244.99	250.83	256.68	262.55
1 - 10	305.99	312.43	318.85	325.28	331.74

COM Yardage: ⅔ yd. - price @ GR 1  
Items Per Carton: 2

Weight: 20 lbs  
Shipping Class: 175



**Double Slat Stool**

## DSBS - PS

### Features

46" H x 17½" W x 20" D  
30" Seat Height  
1½" Thick Seat  
1¼" Rd. Steel Tubing (16 Gauge)  
#15 Platform Glide

### Optional:

24" Seat Height (Add 33.15)

Quantity	Grade 1	Grade 2	Grade 3	Grade 4	Grade 5
7+	331.25	337.08	342.93	348.80	354.64
1 - 6	407.31	413.73	420.15	426.62	433.04

COM Yardage: ⅔ yd. - price @ GR 1  
Items Per Carton: 1

Weight: 30 lbs  
Shipping Class: 175



Fanback Chair

**FB - PS****Features**

37" H x 17½" W x 20" D  
 18" Seat Height  
 1½" Thick Seat  
 1¼" Rd. Steel Tubing (16 Gauge)  
 #15 Platform Glide

Quantity	Grade 1	Grade 2	Grade 3	Grade 4	Grade 5
100+	192.71	198.57	204.43	210.27	216.13
50 – 99	198.57	204.43	210.27	216.13	221.97
11 – 49	204.43	210.27	216.13	221.97	227.82
1 – 10	267.81	274.23	280.70	287.12	293.54

COM Yardage: ⅔ yd. - price @ GR 1

Weight: 20 lbs

Items Per Carton: 2



Stacking Fanback Chair

**SFB - PS****Features**

37" H x 20" W x 20" D  
 18" Seat Height  
 1½" Thick Seat  
 1¼" Rd. Steel Tubing (16 Gauge)  
 #15 Platform Glide  
 Stacks 6 High

**Stackable Spectrum**

Quantity	Grade 1	Grade 2	Grade 3	Grade 4	Grade 5
100+	226.21	231.80	237.37	242.94	248.50
50 – 99	231.80	237.37	242.94	248.50	254.08
11 – 49	237.37	242.94	248.50	254.08	259.65
1 – 10	302.00	308.12	314.27	320.38	326.50

COM Yardage: ⅔ yd. - price @ GR 1

Weight: 25 lbs

Items Per Carton: 4



Fanback Stool

**FBBS - PS****Features**

46" H x 17½" W x 20" D  
 30" Seat Height  
 1½" Thick Seat  
 1¼" Rd. Steel Tubing (16 Gauge)  
 #15 Platform Glide

Quantity	Grade 1	Grade 2	Grade 3	Grade 4	Grade 5
7+	331.25	337.08	342.93	348.80	354.64
1 – 6	407.31	413.73	420.15	426.62	433.04

COM Yardage: ⅔ yd. - price @ GR 1

Weight: 30 lbs

Items Per Carton: 1

**Optional:**

24" Seat Height (Add 33.15)



Hourglass Chair

**HG - PS****Features**

37" H x 17½" W x 20" D  
 18" Seat Height  
 1½" Thick Seat  
 1¼" Rd. Steel Tubing (16 Gauge)  
 #15 Platform Glide

Quantity	Grade 1	Grade 2	Grade 3	Grade 4	Grade 5
100+	329.49	335.33	341.18	347.05	352.88
50 – 99	335.33	341.18	347.05	352.88	358.72
11 – 49	341.18	347.05	352.88	358.72	364.58
1 – 10	418.23	424.69	431.12	437.54	443.97

COM Yardage: 1½ yds. - price @ GR 1

Weight: 24 lbs

Items Per Carton: 2



Hourglass Stool

**HGBS - PS****Features**

46" H x 17½" W x 20" D  
 30" Seat Height  
 1½" Thick Seat  
 ¼" Rd. Steel Tubing (16 Gauge)  
 #15 Platform Glide

**Optional:**

24" Seat Height (Add 33.15)

Quantity	Grade 1	Grade 2	Grade 3	Grade 4	Grade 5
7+	412.34	418.21	424.05	429.88	435.75
1 - 6	496.52	502.97	509.39	515.81	522.27

COM Yardage: 1⅓ yds. - price @ GR 1

Weight: 32 lbs

Items Per Carton: 1



Hairpin Chair

**HP - PS****Features**

37" H x 17½" W x 20" D  
 18" Seat Height  
 1½" Thick Seat  
 ¼" Rd. Steel Tubing (16 Gauge)  
 #15 Platform Glide

Quantity	Grade 1	Grade 2	Grade 3	Grade 4	Grade 5
100+	228.86	234.69	240.54	246.40	252.25
50 - 99	234.69	240.54	246.40	252.25	258.08
11 - 49	240.54	246.40	252.25	258.08	263.95
1 - 10	307.53	313.97	320.41	326.83	333.27

COM Yardage: ⅔ yd. - price @ GR 1

Weight: 20 lbs

Items Per Carton: 2



Hairpin Stool

**HPBS - PS****Features**

46" H x 17½" W x 20" D  
 30" Seat Height  
 1½" Thick Seat  
 ¼" Rd. Steel Tubing (16 Gauge)  
 #15 Platform Glide

Quantity	Grade 1	Grade 2	Grade 3	Grade 4	Grade 5
7+	331.25	337.08	342.93	348.80	354.64
1 - 6	407.31	413.73	420.15	426.62	433.04

COM Yardage: ⅔ yd. - price @ GR 1

Weight: 30 lbs

Items Per Carton: 1



Inverted "T" Chair

**IT - PS****Features**

37" H x 17½" W x 20" D  
 18" Seat Height  
 1½" Thick Seat  
 ¼" Rd. Steel Tubing (16 Gauge)  
 #15 Platform Glide

Quantity	Grade 1	Grade 2	Grade 3	Grade 4	Grade 5
100+	313.56	319.41	325.25	331.10	336.95
50 - 99	319.41	325.25	331.10	336.95	342.80
11 - 49	325.25	331.10	336.95	342.80	348.66
1 - 10	400.71	407.15	413.58	420.02	426.46

COM Yardage: 1⅓ yds. - price @ GR 1

Weight: 22 lbs

Items Per Carton: 2



Inverted "T" Stool

**ITBS - PS****Features**

46" H x 17½" W x 20" D  
 30" Seat Height  
 1½" Thick Seat  
 1¼" Rd. Steel Tubing (16 Gauge)  
 #15 Platform Glide

**Optional:**

24" Seat Height (Add 33.15)

Quantity	Grade 1	Grade 2	Grade 3	Grade 4	Grade 5
7+	378.92	384.74	390.60	396.46	402.31
1-6	459.72	466.16	472.59	479.01	485.47

COM Yardage: 1½ yds. - price @ GR 1      Weight: 32 lbs

Items Per Carton: 1



Mushroom Chair

**MR - PS****Features**

37" H x 17½" W x 20" D  
 18" Seat Height  
 1½" Thick Seat  
 1¼" Rd. Steel Tubing (16 Gauge)  
 #15 Platform Glide

Quantity	Grade 1	Grade 2	Grade 3	Grade 4	Grade 5
100+	310.74	316.58	322.44	328.29	334.13
50-99	316.58	322.44	328.29	334.13	339.99
11-49	322.44	328.29	334.13	339.99	345.83
1-10	397.63	404.05	410.47	416.94	423.36

COM Yardage: 1½ yds. - price @ GR 1      Weight: 22 lbs

Items Per Carton: 2



Stacking Mushroom Chair

**SMR - PS****Features**

37" H x 20" W x 20" D  
 18" Seat Height  
 1½" Thick Seat  
 1¼" Rd. Steel Tubing (16 Gauge)  
 #15 Platform Glide  
 Stacks 6 High

**Stackable Spectrum**

Quantity	Grade 1	Grade 2	Grade 3	Grade 4	Grade 5
100+	294.14	300.00	305.83	311.68	317.55
50-99	300.00	305.83	311.68	317.55	323.39
11-49	305.83	311.68	317.55	323.39	329.22
1-10	379.36	385.80	392.24	398.66	405.09

COM Yardage: 1½ yds. - price @ GR 1      Weight: 25 lbs

Items Per Carton: 4



Mushroom Stool

**MRBS - PS****Features**

46" H x 17½" W x 20" D  
 30" Seat Height  
 1½" Thick Seat  
 1¼" Rd. Steel Tubing (16 Gauge)  
 #15 Platform Glide

**Optional:**

24" Seat Height (Add 33.15)

Quantity	Grade 1	Grade 2	Grade 3	Grade 4	Grade 5
7+	393.49	399.34	405.20	411.06	416.88
1-6	475.79	482.23	488.65	495.08	501.52

COM Yardage: 1½ yds. - price @ GR 1      Weight: 31 lbs

Items Per Carton: 1



Plain Back Chair

**PB - PS****Features**

37" H x 17½" W x 20" D  
 18" Seat Height  
 1½" Thick Seat  
 1¼" Rd. Steel Tubing (16 Gauge)  
 #15 Platform Glide

Quantity	Grade 1	Grade 2	Grade 3	Grade 4	Grade 5
100+	329.49	335.33	341.18	347.05	352.88
50 – 99	335.33	341.18	347.05	352.88	358.72
11 – 49	341.18	347.05	352.88	358.72	364.58
1 – 10	418.23	424.69	431.12	437.54	443.97

COM Yardage: 1⅓ yds. - price @ GR 1      Weight: 25lbs  
 Items Per Carton: 2



Plain Back Stool

**PBBS - PS****Features**

46" H x 17½" W x 20" D  
 30" Seat Height  
 1½" Thick Seat  
 1¼" Rd. Steel Tubing (16 Gauge)  
 #15 Platform Glide

Quantity	Grade 1	Grade 2	Grade 3	Grade 4	Grade 5
7+	412.27	418.13	423.98	429.83	435.68
1 – 6	496.43	502.87	509.32	515.74	522.17

COM Yardage: 1⅓ yds. - price @ GR 1      Weight: 32lbs  
 Items Per Carton: 1

**Optional:**

24" Seat Height (Add 33.15)



Round Back Chair

**RB - PS****Features**

37" H x 17½" W x 20" D  
 18" Seat Height  
 1½" Thick Seat  
 1¼" Rd. Steel Tubing (16 Gauge)  
 #15 Platform Glide

Quantity	Grade 1	Grade 2	Grade 3	Grade 4	Grade 5
100+	313.27	319.12	324.97	330.81	336.68
50 – 99	319.12	324.97	330.81	336.68	342.52
11 – 49	324.97	330.81	336.68	342.52	348.36
1 – 10	400.41	406.83	413.28	419.70	426.13

COM Yardage: 1⅓ yds. - price @ GR 1      Weight: 21lbs  
 Items Per Carton: 2



Round Back Stool

**RBBS - PS****Features**

46" H x 17½" W x 20" D  
 30" Seat Height  
 1½" Thick Seat  
 1¼" Rd. Steel Tubing (16 Gauge)  
 #15 Platform Glide

Quantity	Grade 1	Grade 2	Grade 3	Grade 4	Grade 5
7+	388.09	393.95	399.81	405.65	411.51
1 – 6	469.86	476.28	482.72	489.15	495.59

COM Yardage: 1⅓ yds. - price @ GR 1      Weight: 31lbs  
 Items Per Carton: 1

**Optional:**

24" Seat Height (Add 33.15)



Stacking Smooth Back Chair

**SSB - PS****Features**

37" H x 20" W x 20" D  
 18" Seat Height  
 1½" Thick Seat  
 1¼" Rd. Steel Tubing (16 Gauge)  
 #15 Platform Glide  
 Stacks 6 High

**Stackable Spectrum**

Quantity	Grade 1	Grade 2	Grade 3	Grade 4	Grade 5
100+	288.86	294.72	300.56	306.42	312.27
50 – 99	294.72	300.56	306.42	312.27	318.11
11 – 49	300.56	306.42	312.27	318.11	323.97
1 – 10	373.55	380.01	386.43	392.86	399.31

COM Yardage: 1½ yds. - price @ GR 1      Weight: 25 lbs  
 Items Per Carton: 4



Smooth Back Stool

**SBBS - PS****Features**

46" H x 17½" W x 20" D  
 30" Seat Height  
 1½" Thick Seat  
 1¼" Rd. Steel Tubing (16 Gauge)  
 #15 Platform Glide

**Optional:**

24" Seat Height (Add 33.15)

Quantity	Grade 1	Grade 2	Grade 3	Grade 4	Grade 5
7+	383.30	389.15	395.02	400.86	406.69
1 – 6	464.57	471.02	477.46	483.88	490.30

COM Yardage: 1½ yds. - price @ GR 1      Weight: 30 lbs  
 Items Per Carton: 1



Upholstered Fanback Chair

**UFB - PS****Features**

37" H x 17½" W x 20" D  
 18" Seat Height  
 1½" Thick Seat  
 1¼" Rd. Steel Tubing (16 Gauge)  
 #15 Platform Glide

Quantity	Grade 1	Grade 2	Grade 3	Grade 4	Grade 5
100+	357.15	362.99	368.85	374.70	380.55
50 – 99	362.99	368.85	374.70	380.55	386.41
11 – 49	368.85	374.70	380.55	386.41	392.24
1 – 10	448.67	455.09	461.54	467.98	474.40

COM Yardage: 1½ yds. - price @ GR 1      Weight: 24 lbs  
 Items Per Carton: 2



Upholstered Fanback Stool

**UFBBS - PS****Features**

46" H x 17½" W x 20" D  
 30" Seat Height  
 1½" Thick Seat  
 1¼" Rd. Steel Tubing (16 Gauge)  
 #15 Platform Glide

**Optional:**

24" Seat Height (Add 33.15)

Quantity	Grade 1	Grade 2	Grade 3	Grade 4	Grade 5
7+	419.51	425.38	431.23	437.08	442.93
1 – 6	504.41	510.86	517.28	523.71	530.17

COM Yardage: 1½ yds. - price @ GR 1      Weight: 32 lbs  
 Items Per Carton: 1



Upholstered Hairpin Chair

**UHP - PS****Features**

37" H x 17½" W x 20" D  
 18" Seat Height  
 1½" Thick Seat  
 1¼" Rd. Steel Tubing (16 Gauge)  
 #15 Platform Glide

Quantity	Grade 1	Grade 2	Grade 3	Grade 4	Grade 5
100+	292.15	297.99	303.86	309.70	315.54
50 - 99	297.99	303.86	309.70	315.54	321.42
11 - 49	303.86	309.70	315.54	321.42	327.26
1 - 10	377.16	383.61	390.05	396.47	402.92

COM Yardage: 1⅓ yds. - price @ GR 1      Weight: 22lbs  
 Items Per Carton: 2



Upholstered Hairpin Stool

**UHPBS - PS****Features**

46" H x 17½" W x 20" D  
 30" Seat Height  
 1½" Thick Seat  
 1¼" Rd. Steel Tubing (16 Gauge)  
 #15 Platform Glide

Quantity	Grade 1	Grade 2	Grade 3	Grade 4	Grade 5
7+	366.45	372.28	378.15	384.00	389.84
1 - 6	446.03	452.46	458.88	465.33	471.76

COM Yardage: 1⅓ yds. - price @ GR 1      Weight: 31lbs  
 Items Per Carton: 1

**Optional:**

24" Seat Height (Add 33.15)



Upholstered Slatback Chair

**USB - PS****Features**

37" H x 17½" W x 20" D  
 18" Seat Height  
 1½" Thick Seat  
 1¼" Rd. Steel Tubing (16 Gauge)  
 #15 Platform Glide

Quantity	Grade 1	Grade 2	Grade 3	Grade 4	Grade 5
100+	276.19	282.04	287.90	293.73	299.58
50 - 99	282.04	287.90	293.73	299.58	305.44
11 - 49	287.90	293.73	299.58	305.44	311.29
1 - 10	359.61	366.04	372.48	378.92	385.35

COM Yardage: 1⅓ yds. - price @ GR 1      Weight: 21lbs  
 Items Per Carton: 2



Upholstered Slatback Stool

**USBBS - PS****Features**

46" H x 17½" W x 20" D  
 30" Seat Height  
 1½" Thick Seat  
 1¼" Rd. Steel Tubing (16 Gauge)  
 #15 Platform Glide

Quantity	Grade 1	Grade 2	Grade 3	Grade 4	Grade 5
7+	359.04	364.88	370.72	376.59	382.43
1 - 6	437.88	444.30	450.74	457.19	463.61

COM Yardage: 1⅓ yds. - price @ GR 1      Weight: 31lbs  
 Items Per Carton: 1

**Optional:**

24" Seat Height (Add 33.15)



*Backless Stool*

**BLBS - PS**

**Features**

- 30" H x 16½" W x 16½" D
- 1½" Thick Seat
- 1¼" Rd. Steel Tubing (16 Gauge)
- #15 Platform Glide

**Optional:**

- 24" Seat Height (Add 33.15)

Quantity	Grade 1	Grade 2	Grade 3	Grade 4	Grade 5
7+	214.51	220.36	226.20	232.06	237.90
1 - 6	278.90	285.33	291.75	298.21	304.64

COM Yardage: ⅔ yds. - price @ GR 1      Weight: 22 lbs  
 Items Per Carton: 1

# Stacker Chair Series



## RO - 150 SH

### Features

36" H x 17" W x 19" D  
18" Seat Height  
2" Sewn Hood Seat  
<sup>13</sup>/<sub>16</sub>" Sq. Steel Tubing (16 Gauge)  
#1 Platform Glide

### Optional

Add 57.68 for Chrome

Quantity	Grade 1	Grade 2	Grade 3	Grade 4	Grade 5
100+	207.99	213.84	219.69	225.53	231.39
50 - 99	213.84	219.69	225.53	231.39	237.25
11 - 49	219.69	225.53	231.39	237.25	243.08
1 - 10	284.60	291.02	297.47	303.91	310.33

COM Yardage: 1 yd. - price @ GR 1

Weight: 21 lbs

Items Per Carton: 3



## RO - 200 WF

### Features

36" H x 17" W x 19" D  
18" Seat Height  
2" Waterfall Seat  
<sup>13</sup>/<sub>16</sub>" Sq. Steel Tubing (16 Gauge)  
#1 Platform Glide

### Optional

Add 57.68 for Chrome

Quantity	Grade 1	Grade 2	Grade 3	Grade 4	Grade 5
100+	207.99	213.84	219.69	225.53	231.39
50 - 99	213.84	219.69	225.53	231.39	237.25
11 - 49	219.69	225.53	231.39	237.25	243.08
1 - 10	284.60	291.02	297.47	303.91	310.33

COM Yardage: 1 yd. - price @ GR 1

Weight: 21 lbs

Items Per Carton: 3



## X - 6

### Features

36" H x 16½" W x 20" D  
18" Seat Height  
1" Pulled Seat  
<sup>13</sup>/<sub>16</sub>" Sq. Steel Tubing (16 Gauge)  
#1 Platform Glide

### Optional

Add 57.68 for Chrome

Quantity	Grade 1	Grade 2	Grade 3	Grade 4	Grade 5
100+	185.80	191.65	197.47	203.35	209.21
50 - 99	191.65	197.47	203.35	209.21	215.04
11 - 49	197.47	203.35	209.21	215.04	220.88
1 - 10	260.16	266.62	273.04	279.46	285.93

COM Yardage: ¾ yd. - price @ GR 1

Weight: 20 lbs

Items Per Carton: 4



## X - 10

### Features

33" H x 16" W x 19" D  
18" Seat Height  
1" Pulled Seat  
<sup>13</sup>/<sub>16</sub>" Sq. Steel Tubing (16 Gauge)  
#1 Platform Glide

### Optional

Add 57.68 for Chrome (Shown Here)

Quantity	Grade 1	Grade 2	Grade 3	Grade 4	Grade 5
100+	173.39	179.24	185.11	190.95	196.79
50 - 99	179.24	185.11	190.95	196.79	202.66
11 - 49	185.11	190.95	196.79	202.66	208.50
1 - 10	246.56	252.98	259.42	265.87	272.29

COM Yardage: ⅔ yd. - price @ GR 1

Weight: 19 lbs

Items Per Carton: 4



**X - 18**

**Features**

- 34" H x 18" W x 22" D
- 18" Seat Height
- 1" Pulled Seat
- 3/16" Sq. Steel Tubing (16 Gauge)
- #1 Platform Glide

**Optional**

Add 57.68 for Chrome

Quantity	Grade 1	Grade 2	Grade 3	Grade 4	Grade 5
100+	162.79	168.64	174.50	180.36	186.18
50 – 99	168.64	174.50	180.36	186.18	192.04
11 – 49	174.50	180.36	186.18	192.04	197.90
1 – 10	234.88	241.32	247.74	254.16	260.63

COM Yardage: 3/4 yd. - price @ GR 1      Weight: 21 lbs  
Items Per Carton: 4



**X - 18 LS**

**Features**

- 34" H x 18" W x 22" D
- 18" Seat Height
- 2" Pulled Seat
- 3/16" Sq. Steel Tubing (16 Gauge)
- #1 Platform Glide

**Optional**

Add 57.68 for Chrome

Quantity	Grade 1	Grade 2	Grade 3	Grade 4	Grade 5
100+	184.93	190.78	196.62	202.49	208.32
50 – 99	190.78	196.62	202.49	208.32	214.17
11 – 49	196.62	202.49	208.32	214.17	220.04
1 – 10	259.23	265.65	272.10	278.52	284.96

COM Yardage: 3/4 yd. - price @ GR 1      Weight: 21 lbs  
Items Per Carton: 4



**X - 18 LSIB**

**Features**

- 34" H x 18" W x 22" D
- 18" Seat Height
- 2" Pulled Seat
- 3/16" Sq. Steel Tubing (16 Gauge)
- #1 Platform Glide

**Optional**

Add 57.68 for Chrome

Quantity	Grade 1	Grade 2	Grade 3	Grade 4	Grade 5
100+	216.97	222.82	228.67	234.52	240.36
50 – 99	222.82	228.67	234.52	240.36	246.22
11 – 49	228.67	234.52	240.36	246.22	252.07
1 – 10	294.46	300.91	307.34	313.77	320.22

COM Yardage: 1 yd. - price @ GR 1      Weight: 21 lbs  
Items Per Carton: 4



Optional Seat Pads

**Extra Features For Stacker Chairs**

Luxury Seat.....	add 22.09	Diamond Back.....	add 44.96
Sewn Hood.....	add 27.61	Arm Rest*.....	add 73.63
Waterfall Seat.....	add 27.61	Stacking Bars.....	add 29.01
Inverted Seam.....	add 27.61	Stretcher Bar.....	add 22.08
Channel Back.....	add 38.58	Premium Paint .....	add 14.66
		Powder Chrome.....	Add 29.28

\*Not available with all series

Refer To Page 65 For Extra Chair Features



**X - 23**

**Features**

- 33" H x 18" W x 22" D
- 18" Seat Height
- 1" Pulled Seat
- 1<sup>3</sup>/<sub>16</sub>" Sq. Steel Tubing (16 Gauge)
- #1 Platform Glide

**Optional**

Add 57.68 for Chrome

Quantity	Grade 1	Grade 2	Grade 3	Grade 4	Grade 5
100+	125.45	131.31	137.17	143.01	148.85
50 - 99	131.31	137.17	143.01	148.85	154.72
11 - 49	137.17	143.01	148.85	154.72	160.56
1 - 10	193.83	200.25	206.68	213.14	219.56

COM Yardage: 2/3 yd. - price @ GR 1      Weight: 21 lbs

Items Per Carton: 4



**X - 23 AR**

**Features**

- 33" H x 25<sup>1</sup>/<sub>2</sub>" W x 22" D
- 18" Seat Height
- 1" Pulled Seat
- 1<sup>3</sup>/<sub>16</sub>" Sq. Steel Tubing (16 Gauge)
- #1 Platform Glide

**Optional**

Add 85.92 for Chrome

Quantity	Grade 1	Grade 2	Grade 3	Grade 4	Grade 5
100+	199.08	204.95	210.79	216.62	222.49
50 - 99	204.95	210.79	216.62	222.49	228.34
11 - 49	210.79	216.62	222.49	228.34	234.18
1 - 10	274.81	281.23	287.68	294.10	300.54

COM Yardage: 2/3 yd. - price @ GR 1      Weight: 25 lbs

Items Per Carton: 4



**X - 24 Econo**

**Features**

- 33" H x 18" W x 22" D
- 18" Seat Height
- 1" Pulled Seat
- 1<sup>3</sup>/<sub>16</sub>" Sq. Steel Tubing (16 Gauge)
- #2 Economy Glide

**Optional**

- Available in Textured Black Only

**Made in the U.S.A.**

Quantity	Grade 1
250+	105.01
100+	110.90
50 - 99	116.68
24 - 49	138.13

COM Yardage: N/A

Weight: 21 lbs

Items Per Carton: 4

\* Shown with textured black frame & cranberry upholstery



**Chair Caddy**, is a 2 piece design permits shipping by UPS, 8 chair capacity.

**Weight:** 28 lbs

**Replacement Wheels:** 54.83 each

**342.37**

\* For model X - 43, use code CDD - 43

\*Spectrum series stacks 6 high

**Chair Dolly**, single model has 10 chair capacity, while the double model has a 20 chair capacity.

**Weight:** 10 lbs single / 20 lbs double



**209.86**      Single

**271.71**      Double

\* For model X - 43, use code DOL - 43

\* Not to be used with Spectrum Series chairs

## Refer To Page 65 For Extra Chair Features

**X - 25****Features**

36" H x 18" W x 22" D  
 18" Seat Height  
 1" Pulled Seat  
 $\frac{1}{16}$ " Sq. Steel Tubing (16 Gauge)  
 #2 Economy Glide

**Optional**

Add 57.68 for Chrome

Quantity	Grade 1	Grade 2	Grade 3	Grade 4	Grade 5
100+	143.52	149.34	155.20	161.06	166.91
50 - 99	149.34	155.20	161.06	166.91	172.73
11 - 49	155.20	161.06	166.91	172.73	178.61
1 - 10	213.66	220.10	226.52	232.97	239.41

COM Yardage:  $\frac{2}{3}$  yd. - price @ GR 1

Weight: 22 lbs

Items Per Carton: 4

**X - 25 WF****Features**

36" H x 18" W x 22" D  
 18" Seat Height  
 2" Waterfall Seat  
 $\frac{1}{16}$ " Sq. Steel Tubing (16 Gauge)  
 #2 Economy Glide

**Optional**

Add 57.68 for Chrome

Quantity	Grade 1	Grade 2	Grade 3	Grade 4	Grade 5
100+	171.13	177.00	182.84	188.68	194.54
50 - 99	177.00	182.84	188.68	194.54	200.39
11 - 49	182.84	188.68	194.54	200.39	206.23
1 - 10	244.05	250.48	256.94	263.36	269.78

COM Yardage:  $\frac{3}{4}$  yd. - price @ GR 1

Weight: 22 lbs

Items Per Carton: 4

**X - 25 ISDT****Features**

36" H x 18" W x 22" D  
 18" Seat Height  
 2" Waterfall Seat  
 $\frac{1}{16}$ " Sq. Steel Tubing (16 Gauge)  
 #2 Economy Glide  
 Diamond Back

**Optional**

Add 57.68 for Chrome

Quantity	Grade 1	Grade 2	Grade 3	Grade 4	Grade 5
100+	198.80	204.63	210.48	216.34	222.19
50 - 99	204.63	210.48	216.34	222.19	228.05
11 - 49	210.48	216.34	222.19	228.05	233.87
1 - 10	274.46	280.92	287.35	293.77	300.22

COM Yardage:  $\frac{3}{4}$  yd. - price @ GR 1

Weight: 22 lbs

Items Per Carton: 4

**X - 25 WFCB****Features**

36" H x 18" W x 22" D  
 18" Seat Height  
 2" Waterfall Seat  
 $\frac{1}{16}$ " Sq. Steel Tubing (16 Gauge)  
 #2 Economy Glide  
 Channel Back

**Optional**

Add 57.68 for Chrome

Quantity	Grade 1	Grade 2	Grade 3	Grade 4	Grade 5
100+	198.80	204.63	210.48	216.34	222.19
50 - 99	204.63	210.48	216.34	222.19	228.05
11 - 49	210.48	216.34	222.19	228.05	233.87
1 - 10	274.46	280.92	287.35	293.77	300.22

COM Yardage:  $\frac{3}{4}$  yd. - price @ GR 1

Weight: 22 lbs

Items Per Carton: 4

## Refer To Page 65 For Extra Chair Features

\*All Frames Are Painted Only

**X - 37****Features**

34" H x 18" W x 19" D  
 18" Seat Height  
 1" Pulled Seat  
 1<sup>3</sup>/<sub>16</sub>" Sq. Steel Tubing (16 gauge)  
 #1 Platform Glide

**Paint Only**

Add 29.28 for Powder Chrome (Shown Here)

Quantity	Grade 1	Grade 2	Grade 3	Grade 4	Grade 5
100+	184.45	190.30	196.17	202.00	207.84
50 - 99	190.30	196.17	202.00	207.84	213.71
11 - 49	196.17	202.00	207.84	213.71	219.56
1 - 10	258.71	265.15	271.57	278.02	284.45

COM Yardage: 3/4 yd. - price @ GR 1

Weight: 22lbs

Items Per Carton: 4

**X - 37 LS****Features**

34" H x 18" W x 19" D  
 18" Seat Height  
 2" Pulled Seat  
 1<sup>3</sup>/<sub>16</sub>" Sq. Steel Tubing (16 Gauge)  
 #1 Platform Glide

**Paint Only**

Quantity	Grade 1	Grade 2	Grade 3	Grade 4	Grade 5
100+	206.53	212.36	218.21	224.08	229.93
50 - 99	212.36	218.21	224.08	229.93	235.75
11 - 49	218.21	224.08	229.93	235.75	241.61
1 - 10	282.96	289.43	295.85	302.27	308.71

COM Yardage: 3/4 yd. - price @ GR 1

Weight: 22lbs

Items Per Carton: 4

**X - 37 WF****Features**

34" H x 18" W x 19" D  
 18" Seat Height  
 2" Waterfall Seat  
 1<sup>3</sup>/<sub>16</sub>" Sq. Steel Tubing (16 Gauge)  
 #1 Platform Glide

**Paint Only**

Quantity	Grade 1	Grade 2	Grade 3	Grade 4	Grade 5
100+	212.15	217.98	223.83	229.70	235.54
50 - 99	217.98	223.83	229.70	235.54	241.37
11 - 49	223.83	229.70	235.54	241.37	247.23
1 - 10	289.14	295.61	302.03	308.45	314.92

COM Yardage: 3/4 yd. - price @ GR 1

Weight: 22lbs

Items Per Carton: 4

**X - 37 ISCB****Features**

34" H x 18" W x 19" D  
 18" Seat Height  
 2" Inverted Seam Seat  
 Channel Back  
 1<sup>3</sup>/<sub>16</sub>" Sq. Steel Tubing (16 Gauge)  
 #1 Platform Glide

**Paint Only**

Add 29.28 for Powder Chrome (Shown Here)

Quantity	Grade 1	Grade 2	Grade 3	Grade 4	Grade 5
100+	239.62	245.44	251.31	257.16	263.01
50 - 99	245.44	251.31	257.16	263.01	268.88
11 - 49	251.31	257.16	263.01	268.88	274.71
1 - 10	319.38	325.82	332.24	338.69	345.11

COM Yardage: 3/4 yd. - price @ GR 1

Weight: 22lbs

Items Per Carton: 4

## Refer To Page 65 For Extra Chair Features

**X - 38****Features**

34" H x 18" W x 19" D  
 18" Seat Height  
 1" Pulled Seat  
 1<sup>3</sup>/<sub>16</sub>" Sq. Steel Tubing (16 Gauge)  
 #1 Platform Glide

**Optional**

Add 57.68 for Chrome

Quantity	Grade 1	Grade 2	Grade 3	Grade 4	Grade 5
100+	165.80	171.65	177.49	183.35	189.19
50 - 99	171.65	177.49	183.35	189.19	195.04
11 - 49	177.49	183.35	189.19	195.04	200.91
1 - 10	238.19	244.62	251.04	257.49	263.92

COM Yardage: 3/4 yd. - price @ GR 1

Weight: 21 lbs

Items Per Carton: 4

**X - 38 LS****Features**

34" H x 18" W x 19" D  
 18" Seat Height  
 2" Pulled Seat  
 1<sup>3</sup>/<sub>16</sub>" Sq. Steel Tubing (16 Gauge)  
 #1 Platform Glide

**Optional**

Add 57.68 for Chrome

Quantity	Grade 1	Grade 2	Grade 3	Grade 4	Grade 5
100+	187.90	193.75	199.59	205.44	211.30
50 - 99	193.75	199.59	205.44	211.30	217.15
11 - 49	199.59	205.44	211.30	217.15	222.98
1 - 10	262.49	268.92	275.37	281.79	288.23

COM Yardage: 3/4 yd. - price @ GR 1

Weight: 21 lbs

Items Per Carton: 4

**X - 38 WF****Features**

34" H x 18" W x 19" D  
 18" Seat Height  
 2" Waterfall Seat  
 1<sup>3</sup>/<sub>16</sub>" Sq. Steel Tubing (16 Gauge)  
 #1 Platform Glide

**Optional**

Add 57.68 for Chrome

Quantity	Grade 1	Grade 2	Grade 3	Grade 4	Grade 5
100+	193.37	199.20	205.08	210.91	216.76
50 - 99	199.20	205.08	210.91	216.76	222.62
11 - 49	205.08	210.91	216.76	222.62	228.45
1 - 10	268.51	274.93	281.35	287.81	294.24

COM Yardage: 3/4 yd. - price @ GR 1

Weight: 21 lbs

Items Per Carton: 4

**X - 38 LSDT****Features**

34" H x 18" W x 19" D  
 18" Seat Height  
 2" Pulled Seat  
 1<sup>3</sup>/<sub>16</sub>" Sq. Steel Tubing (16 Gauge)  
 #1 Platform Glide

Diamond Tufted Back

Chrome Nails

**Optional**

Add 57.68 for Chrome

Quantity	Grade 1	Grade 2	Grade 3	Grade 4	Grade 5
100+	215.41	221.26	227.10	232.95	238.80
50 - 99	221.26	227.10	232.95	238.80	244.65
11 - 49	227.10	232.95	238.80	244.65	250.50
1 - 10	292.75	299.19	305.63	312.05	318.50

COM Yardage: 3/4 yd. - price @ GR 1

Weight: 21 lbs

Items Per Carton: 4

## Refer To Page 65 For Extra Chair Features

\*X-43 Frames Are Painted Only



### X - 43

#### Features

32" H x 18" W x 22" D  
18" Seat Height  
1" Pulled Seat  
1" Sq. Steel Tubing (16 Gauge)  
#1 Platform Glide

**Paint Only**

Quantity	Grade 1	Grade 2	Grade 3	Grade 4	Grade 5
100+	196.94	202.79	208.65	214.50	220.33
50 - 99	202.79	208.65	214.50	220.33	226.19
11 - 49	208.65	214.50	220.33	226.19	232.05
1 - 10	272.44	278.88	285.32	291.74	298.17

COM Yardage: ¾ yd. - price @ GR 1

Weight: 21 lbs

Items Per Carton: 4



### X - 43 WF

#### Features

32" H x 18" W x 22" D  
18" Seat Height  
2" Waterfall Seat  
1" Sq. Steel Tubing (16 Gauge)  
#1 Platform Glide

**Paint Only**

\*Requires Special Chair Caddy

Quantity	Grade 1	Grade 2	Grade 3	Grade 4	Grade 5
100+	224.47	230.31	236.17	242.03	247.86
50 - 99	230.31	236.17	242.03	247.86	253.71
11 - 49	236.17	242.03	247.86	253.71	259.57
1 - 10	302.74	309.16	315.58	322.05	328.47

COM Yardage: ¾ yd. - price @ GR 1

Weight: 21 lbs

Items Per Carton: 4



### X - 43 WFHR

#### Features

32" H x 18" W x 22" D  
18" Seat Height  
2" Waterfall Seat  
1" Sq. Steel Tubing (16 gauge)  
#1 Platform Glide

Head Roll

**Paint Only**

\*Requires Special Chair Caddy

Quantity	Grade 1	Grade 2	Grade 3	Grade 4	Grade 5
100+	252.03	257.88	263.73	269.60	275.42
50 - 99	257.88	263.73	269.60	275.42	281.27
11 - 49	263.73	269.60	275.42	281.27	287.14
1 - 10	333.05	339.49	345.91	352.33	358.78

COM Yardage: ¾ yd. - price @ GR 1

Weight: 21 lbs

Items Per Carton: 4



**Chair Caddy**, is a 2 piece design permits shipping by UPS, 8 chair capacity.

Weight: 28 lbs

Replacement Wheels: 54.83 each

342.37

\*For model X-43, use code CDD-43

\*Spectrum series stacks 6 high

**Chair Dolly**, single model has 10 chair capacity, while the double model has a 20 chair capacity.

Weight: 10 lbs single / 20 lbs double



209.86 Single

271.71 Double

\*For model X-43, use code DOL-43

\*Not to be used with Spectrum Series chairs

## Refer To Page 65 For Extra Chair Features

**X - 45****Features**

34" H x 18" W x 19" D  
 18" Seat Height  
 1" Pulled Seat  
 $\frac{1}{4}$ " Sq. Steel Tubing (16 Gauge)  
 #1 Platform Glide

**Optional**

Add 57.68 for Chrome

Quantity	Grade 1	Grade 2	Grade 3	Grade 4	Grade 5
100+	145.45	151.30	157.17	163.00	168.84
50 - 99	151.30	157.17	163.00	168.84	174.71
11 - 49	157.17	163.00	168.84	174.71	180.56
1 - 10	215.81	222.23	228.61	235.12	241.54

COM Yardage:  $\frac{2}{3}$  yd. - price @ GR 1

Weight: 22 lbs

Items Per Carton: 4

**X - 45 LS****Features**

34" H x 18" W x 19" D  
 18" Seat Height  
 2" Pulled Seat  
 $\frac{1}{4}$ " Sq. Steel Tubing (16 Gauge)  
 #1 Platform Glide

**Optional**

Add 57.68 for Chrome

Quantity	Grade 1	Grade 2	Grade 3	Grade 4	Grade 5
100+	167.52	173.36	179.22	185.08	190.91
50 - 99	173.36	179.22	185.08	190.91	196.77
11 - 49	179.22	185.08	190.91	196.77	202.63
1 - 10	240.08	246.52	252.95	259.38	265.83

COM Yardage:  $\frac{3}{4}$  yd. - price @ GR 1

Weight: 22 lbs

Items Per Carton: 4

**X - 45 SH****Features**

34" H x 18" W x 19" D  
 18" Seat Height  
 2" Sewn Hood Seat  
 $\frac{1}{4}$ " Sq. Steel Tubing (16 Gauge)  
 #1 Platform Glide

**Optional**

Add 57.68 for Chrome

Quantity	Grade 1	Grade 2	Grade 3	Grade 4	Grade 5
100+	173.06	178.89	184.74	190.60	196.45
50 - 99	178.89	184.74	190.60	196.45	202.31
11 - 49	184.74	190.60	196.45	202.31	208.15
1 - 10	246.15	252.61	259.03	265.46	271.90

COM Yardage:  $\frac{3}{4}$  yd. - price @ GR 1

Weight: 22 lbs

Items Per Carton: 4

**X - 45 WFCB****Features**

34" H x 18" W x 19" D  
 18" Seat Height  
 2" Waterfall Seat  
 $\frac{1}{4}$ " Sq. Steel Tubing (16 Gauge)  
 #1 Platform Glide  
 Channel Back

**Optional**

Add 57.68 for Chrome

Quantity	Grade 1	Grade 2	Grade 3	Grade 4	Grade 5
100+	211.64	217.49	223.36	229.21	235.03
50 - 99	217.49	223.36	229.21	235.03	240.91
11 - 49	223.36	229.21	235.03	240.91	246.75
1 - 10	288.63	295.05	301.48	307.94	314.36

COM Yardage:  $\frac{3}{4}$  yd. - price @ GR 1

Weight: 22 lbs

Items Per Carton: 4

# School Series



## 907 - 242 WF

### Features

29¼" H x 22½" W x 20" D  
18" Seat Height  
2" Waterfall Seat  
#7 Platform Glide  
#20 DBL Plate  
Swivels 360°

### Optional

Add 76.79 for Chrome (Shown Here)

Quantity	Grade 1	Grade 2	Grade 3	Grade 4	Grade 5
100+	423.35	429.08	434.83	440.55	446.29
50 - 99	429.08	434.83	440.55	446.29	452.03
11 - 49	434.83	440.55	446.29	452.03	457.76
1 - 10	520.40	526.70	533.01	539.32	545.63

COM Yardage: 1¼ yds. - price @ GR 1

Weight: 25 lbs

Items Per Carton: 1



## S - 3 Tilting

### Features

31" H x 20½" W x 25¾" D  
18" Seat Height  
1" Pulled Seat  
16 Gauge Frame  
Painted Frame Standard

### Optional

Call factory for chrome pricing

Quantity	Grade 1	Grade 2	Grade 3	Grade 4	Grade 5
100+	461.04	466.77	472.52	478.25	483.98
50 - 99	466.77	472.52	478.25	483.98	489.73
11 - 49	472.52	478.25	483.98	489.73	495.45
1 - 10	561.86	568.16	574.47	580.79	590.81

COM Yardage: ¾ yd. - price @ GR 1

Weight: 26 lbs

Items Per Carton: 1



## S - 4 Non - Tilting

### Features

31" H x 20½" W x 25¾" D  
18" Seat Height  
1" Pulled Seat  
16 Gauge Frame  
Painted Frame Standard

### Optional

Call factory for chrome pricing

Quantity	Grade 1	Grade 2	Grade 3	Grade 4	Grade 5
100+	442.28	448.01	453.77	459.50	465.21
50 - 99	448.01	453.77	459.50	465.21	470.97
11 - 49	453.77	459.50	465.21	470.97	476.70
1 - 10	541.24	547.53	553.85	560.16	566.46

COM Yardage: ¾ yd. - price @ GR 1

Weight: 26 lbs

Items Per Carton: 1

# Parlor Series

All Parlor Chairs and Barstools are available with a wood seat. Please contact the factory for pricing.



Parlor Hairpin Chair

## X - 52

### Features

35" H x 16" W x 19" D

18" Seat Height

1" Pulled Seat

### 16 Gauge Frame

#13 Platform Glide

### Optional:

Add 80.97 for Chrome

Call Factory For Wood Seat Option

Quantity	Grade 1	Grade 2	Grade 3	Grade 4	Grade 5
100+	154.11	159.96	165.81	171.66	177.52
50 - 99	159.96	165.81	171.66	177.52	183.38
11 - 49	165.81	171.66	177.52	183.38	189.21
1 - 10	225.34	231.76	238.20	244.65	251.07

COM Yardage: 1/3 yd. - price @ GR 1

Weight: 19 lbs

Items Per Carton: 2

Shipping Class: 150



Parlor Hairpin Stool

## X - 52 BS

### Features

43" H x 16" W x 20 1/2" D

30" Seat Height Only

1" Pulled Seat

### 16 Gauge Frame

#13 Platform Glide

### Optional:

Add 102.42 for Chrome

Call Factory For Wood Seat Option

Quantity	Grade 1	Grade 2	Grade 3	Grade 4	Grade 5
7+	256.89	262.75	268.59	274.45	280.31
1 - 6	325.55	331.97	338.39	344.84	351.26

COM Yardage: 2/3 yd. - price @ GR 1

Weight: 23 lbs

Items Per Carton: 1

Shipping Class: 150



Parlor Sweetheart Chair

## X - 53

### Features

33 1/2" H x 16" W x 19" D

18" Seat Height

1" Pulled Seat

### 16 Gauge Frame

#13 Platform Glide

### Optional:

Add 80.97 for Chrome

Call Factory For Wood Seat Option

Quantity	Grade 1	Grade 2	Grade 3	Grade 4	Grade 5
100+	172.54	178.39	184.25	190.09	195.93
50 - 99	178.39	184.25	190.09	195.93	201.80
11 - 49	184.25	190.09	195.93	201.80	207.64
1 - 10	245.60	252.03	258.48	264.92	271.34

COM Yardage: 1/3 yd. - price @ GR 1

Weight: 19 lbs

Items Per Carton: 2

Shipping Class: 150



Parlor Sweetheart Stool

## X - 53 BS

### Features

43" H x 16" W x 20 1/2" D

30" Seat Height Only

1" Pulled Seat

### 16 Gauge Frame

#13 Platform Glide

### Optional:

Add 102.42 for Chrome

Call Factory For Wood Seat Option

Quantity	Grade 1	Grade 2	Grade 3	Grade 4	Grade 5
7+	270.34	276.19	282.04	287.90	293.73
1 - 6	340.30	346.73	353.19	359.61	366.04

COM Yardage: 1/3 yd. - price @ GR 1

Weight: 23 lbs

Items Per Carton: 1

Shipping Class: 150

# All Frames Are 16 Steel Gauge

All Parlor Chairs and Barstools are available with a wood seat. Please contact the factory for pricing.



Parlor Upholstered  
Hairpin Chair

## X - 54

### Features

35" H x 16" W x 19½" D  
18" Seat Height  
1" Pulled Seat

### 16 Gauge Frame

#13 Platform Glide

### Optional:

Add 80.97 for Chrome  
Call Factory For Wood Seat Option

Quantity	Grade 1	Grade 2	Grade 3	Grade 4	Grade 5
100+	185.31	191.15	197.02	202.86	208.71
50 - 99	191.15	197.02	202.86	208.71	214.56
11 - 49	197.02	202.86	208.71	214.56	220.41
1 - 10	259.67	266.09	272.51	278.97	285.40

COM Yardage: ½ yd. - price @ GR 1

Weight: 22 lbs

Items Per Carton: 2



Parlor Upholstered  
Hairpin Stool

## X - 54 BS

### Features

43" H x 16" W x 20½" D  
30" Seat Height Only  
1" Pulled Seat

### 16 Gauge Frame

#13 Platform Glide

### Optional:

Add 102.42 for Chrome  
Call Factory For Wood Seat Option

Quantity	Grade 1	Grade 2	Grade 3	Grade 4	Grade 5
7+	325.57	331.42	337.26	343.11	348.97
1 - 6	401.07	407.50	413.92	420.36	426.80

COM Yardage: ½ yd. - price @ GR 1

Weight: 25 lbs

Items Per Carton: 1



Parlor Fanback Chair  
(4 Spindle)

## X - 56

### Features

35" H x 16" W x 19½" D  
18" Seat Height  
1" Pulled Seat

### 16 Gauge Frame

#13 Platform Glide

### Optional:

Add 80.97 for Chrome  
Call Factory For Wood Seat Option

Quantity	Grade 1	Grade 2	Grade 3	Grade 4	Grade 5
100+	162.25	168.11	173.95	179.79	185.65
50 - 99	168.11	173.95	179.79	185.65	191.50
11 - 49	173.95	179.79	185.65	191.50	197.34
1 - 10	234.28	240.74	247.14	253.59	260.02

COM Yardage: ½ yd. - price @ GR 1

Weight: 19 lbs

Items Per Carton: 2



Parlor Fanback Stool

## X - 55 BS

### Features

43" H x 16" W x 20½" D  
30" Seat Height Only  
1" Pulled Seat

### 16 Gauge Frame

#13 Platform Glide

### Optional:

Add 102.42 for Chrome  
Call Factory For Wood Seat Option

Quantity	Grade 1	Grade 2	Grade 3	Grade 4	Grade 5
7+	266.24	272.10	277.93	283.79	289.65
1 - 6	335.80	342.23	348.67	355.11	361.55

COM Yardage: ½ yd. - price @ GR 1

Weight: 21 lbs

Items Per Carton: 1

# Classic Chairs & Stools



Curved Back

## 921

### Features

31½" H x 15¼" W x 22½" D  
18" Seat Height  
1" Pulled Seat  
1" Rd. Tubing (16 Gauge)  
#6 Platform Glide

### Optional:

Add 27.61 for Sewn Hood Seat

Quantity	Grade 1	Grade 2	Grade 3	Grade 4	Grade 5
100+	176.95	182.80	188.63	194.50	200.34
50 – 99	182.80	188.63	194.50	200.34	206.19
11 – 49	188.63	194.50	200.34	206.19	212.05
1 – 10	250.43	256.87	263.31	269.73	276.17

COM Yardage: ¾ yd. - price @ GR 1

Weight: 17 lbs

Items Per Carton: 2



Curved "V" Back

## 921 "V"

### Features

31½" H x 15¼" W x 22½" D  
18" Seat Height  
1" Pulled Seat  
1" Rd. Tubing (16 Gauge)  
#6 Platform Glide

### Optional:

Add 27.61 for Sewn Hood Seat

Quantity	Grade 1	Grade 2	Grade 3	Grade 4	Grade 5
100+	197.11	202.93	208.76	214.62	220.47
50 – 99	202.93	208.76	214.62	220.47	226.32
11 – 49	208.76	214.62	220.47	226.32	232.17
1 – 10	272.58	279.02	285.47	291.89	298.32

COM Yardage: ¾ yd. - price @ GR 1

Weight: 17 lbs

Items Per Carton: 2



Curved Diamond Tuft Back

## 921 DT

### Features

31½" H x 15¼" W x 22½" D  
18" Seat Height  
1" Pulled Seat  
1" Rd. Tubing (16 Gauge)  
#6 Platform Glide

### Optional:

Add 27.61 for Sewn Hood Seat

Quantity	Grade 1	Grade 2	Grade 3	Grade 4	Grade 5
100+	221.95	227.79	233.64	239.50	245.34
50 – 99	227.79	233.64	239.50	245.34	251.20
11 – 49	233.64	239.50	245.34	251.20	257.06
1 – 10	299.96	306.38	312.82	319.25	325.69

COM Yardage: ¾ yd. - price @ GR 1

Weight: 17 lbs

Items Per Carton: 2



Curved Back Stool

## 921 BS

### Features

43½" H x 15¼" W x 22½" D  
30" Seat Height Only  
1" Pulled Seat  
1" Rd. Tubing (16 Gauge)  
#6 Platform Glide

### Optional:

Add 27.61 for Sewn Hood Seat

Add 38.58 for "V"

Quantity	Grade 1	Grade 2	Grade 3	Grade 4	Grade 5
7+	296.50	302.35	308.18	314.04	319.90
1 – 6	369.08	375.51	381.95	388.39	394.82

COM Yardage: ¾ yd. - price @ GR 1

Weight: 25 lbs

Items Per Carton: 1



Elite Style Back

**921 ELSH****Features**

31½" H x 15¼" W x 22½" D  
 18" Seat Height  
 2" Sewn Hood Seat  
 1" Rd. Steel Tubing (16 Gauge)  
 #6 Platform Glide

Quantity	Grade 1	Grade 2	Grade 3	Grade 4	Grade 5
100+	260.63	266.47	272.33	278.17	284.03
50 – 99	266.47	272.33	278.17	284.03	289.89
11 – 49	272.33	278.17	284.03	289.89	295.72
1 – 10	342.49	348.93	355.37	361.80	368.22

COM Yardage: ¾ yd. - price @ GR 1

Weight: 17lbs

Items Per Carton: 2



Elite Style Stool

**921 ELSH - BS****Features**

43½" H x 15¼" W x 22½" D  
 30" Seat Height Only  
 2" Sewn Hood Seat  
 1" Rd. Steel Tubing (16 Gauge)  
 #6 Platform Glide

Quantity	Grade 1	Grade 2	Grade 3	Grade 4	Grade 5
7+	403.90	409.76	415.62	421.47	427.30
1 – 6	487.23	493.69	500.11	506.54	512.99

COM Yardage: ¾ yd. - price @ GR 1

Weight: 25lbs

Items Per Carton: 1



Malibu Style Back

**921 MBWF****Features**

31½" H x 15¼" W x 22½" D  
 18" Seat Height  
 2" Waterfall Seat  
 1" Rd. Steel Tubing (16 Gauge)  
 #6 Platform Glide

Quantity	Grade 1	Grade 2	Grade 3	Grade 4	Grade 5
100+	260.63	266.47	272.33	278.17	284.03
50 – 99	266.47	272.33	278.17	284.03	289.89
11 – 49	272.33	278.17	284.03	289.89	295.72
1 – 10	342.49	348.93	355.37	361.80	368.22

COM Yardage: ¾ yd. - price @ GR 1

Weight: 17lbs

Items Per Carton: 2



Malibu Style Stool

**921 MBWF - BS****Features**

43½" H x 15¼" W x 22½" D  
 30" Seat Height Only  
 2" Waterfall Seat  
 1" Rd. Steel Tubing (16 Gauge)  
 #6 Platform Glide

Quantity	Grade 1	Grade 2	Grade 3	Grade 4	Grade 5
7+	403.90	409.76	415.62	421.47	427.30
1 – 6	487.23	493.69	500.11	506.54	512.99

COM Yardage: ¾ yd. - price @ GR 1

Weight: 25lbs

Items Per Carton: 1



**Curved Back with  
Chrome Handle**

## 921 HB

### Features

31½" H x 15¼" W x 22½" D  
18" Seat Height  
1" Pulled Seat  
1" Rd. Tubing (16 Gauge)  
#6 Platform Glide

### Optional:

Add 27.61 for Sewn Hood Seat

Quantity	Grade 1	Grade 2	Grade 3	Grade 4	Grade 5
100+	267.62	273.46	279.32	285.17	290.97
50 – 99	273.46	279.32	285.17	290.97	296.87
11 – 49	279.32	285.17	290.97	296.87	302.72
1 – 10	350.20	356.62	363.04	369.50	375.93

COM Yardage: ¾ yd. - price @ GR 1

Weight: 17 lbs

Items Per Carton: 2



**Curved Back Stool  
with Chrome Handle**

## 921 HB - BS

### Features

43½" H x 15¼" W x 22½" D  
30" Seat Height Only  
1" Pulled Seat  
1" Rd. Tubing (16 Gauge)  
#6 Platform Glide

### Optional:

Add 27.61 for Sewn Hood Seat

Quantity	Grade 1	Grade 2	Grade 3	Grade 4	Grade 5
7+	411.03	416.87	422.72	428.59	434.42
1 – 6	495.07	501.50	507.94	514.38	520.80

COM Yardage: ¾ yd. - price @ GR 1

Weight: 25 lbs

Items Per Carton: 1



**Curved Back with  
Chrome Handle**

## 921 HBSH

### Features

31½" H x 15¼" W x 22½" D  
18" Seat Height  
2" Sewn Hood Seat  
1" Rd. Tubing (16 Gauge)  
#6 Platform Glide

### Optional:

Accent Piping (Shown Here)

Quantity	Grade 1	Grade 2	Grade 3	Grade 4	Grade 5
100+	295.25	301.10	306.95	312.80	318.64
50 – 99	301.10	306.95	312.80	318.64	324.50
11 – 49	306.95	312.80	318.64	324.50	330.36
1 – 10	380.58	387.03	393.46	399.88	406.33

COM Yardage: ¾ yd. - price @ GR 1

Weight: 17 lbs

Items Per Carton: 2



**Curved Back Stool  
with Chrome Handle**

## 921 HBWF - BS

### Features

43½" H x 15¼" W x 22½" D  
30" Seat Height Only  
2" Waterfall Seat  
1" Rd. Tubing (16 Gauge)  
#6 Platform Glide

### Optional:

Accent Piping (Shown Here)

Quantity	Grade 1	Grade 2	Grade 3	Grade 4	Grade 5
7+	438.59	444.44	450.29	456.15	461.99
1 – 6	525.39	531.81	538.24	544.70	551.12

COM Yardage: ¾ yd. - price @ GR 1

Weight: 25 lbs

Items Per Carton: 1



Malibu Style Handle Back

**921 HBMBSH****Features**

31½" H x 15¼" W x 22½" D  
 18" Seat Height  
 2" Sewn Hood Seat  
 1" Rd. Steel Tubing (16 Gauge)  
 #6 Platform Glide

Quantity	Grade 1	Grade 2	Grade 3	Grade 4	Grade 5
100+	333.89	339.74	345.60	351.44	357.28
50 – 99	339.74	345.60	351.44	357.28	363.16
11 – 49	345.60	351.44	357.28	363.16	369.00
1 – 10	423.10	429.52	435.97	442.40	448.83

COM Yardage: ¾ yd. - price @ GR 1

Weight: 17lbs

Items Per Carton: 2



Malibu Style Handle Back Stool

**921 HBMBWF - BS****Features**

43½" H x 15¼" W x 22½" D  
 30" Seat Height Only  
 2" Waterfall Seat  
 1" Rd. Steel Tubing (16 Gauge)  
 #6 Platform Glide

Quantity	Grade 1	Grade 2	Grade 3	Grade 4	Grade 5
7+	477.19	483.04	488.88	494.73	500.59
1 – 6	567.86	574.29	580.71	587.13	593.59

COM Yardage: ¾ yd. - price @ GR 1

Weight: 25lbs

Items Per Carton: 1



Classic Button Back

**921 BB****Features**

32" H x 15¼" W x 22½" D  
 18" Seat Height  
 1" Pulled Seat  
 1" Rd. Tubing (16 Gauge)  
 #6 Platform Glide

**Optional:**

Add 27.61 for Sewn Hood Seat

Quantity	Grade 1	Grade 2	Grade 3	Grade 4	Grade 5
100+	197.08	202.93	208.76	214.62	220.47
50 – 99	202.93	208.76	214.62	220.47	226.32
11 – 49	208.76	214.62	220.47	226.32	232.17
1 – 10	272.58	279.02	285.47	291.89	298.32

COM Yardage: ¾ yd. - price @ GR 1

Weight: 17lbs

Items Per Carton: 2



Small Curved Back

**934****Features**

32" H x 17" W x 22½" D  
 18" Seat Height  
 1" Pulled Seat  
 1" Rd. Tubing (16 Gauge)  
 #6 Platform Glide

**Optional:**

Add 27.61 for Sewn Hood Seat

Quantity	Grade 1	Grade 2	Grade 3	Grade 4	Grade 5
100+	220.82	226.66	232.51	238.37	244.21
50 – 99	226.66	232.51	238.37	244.21	250.05
11 – 49	232.51	238.37	244.21	250.05	255.90
1 – 10	298.69	305.12	311.57	318.00	324.43

COM Yardage: ½ yd. - price @ GR 1

Weight: 15lbs

Items Per Carton: 2



**Classic Channel Back**

### 939 CBWF

**Features**

- 32" H x 15¼" W x 22½" D
- 18" Seat Height
- 2" Waterfall Seat
- 1" Rd. Tubing (16 Gauge)
- #6 Platform Glide

**Optional:**

*Add 38.58 for 3 Middle Channels in Different Colored Upholstery*

Quantity	Grade 1	Grade 2	Grade 3	Grade 4	Grade 5
100+	260.63	266.47	272.33	278.17	284.03
50 – 99	266.47	272.33	278.17	284.03	289.89
11 – 49	272.33	278.17	284.03	289.89	295.72
1 – 10	342.49	348.93	355.37	361.80	368.22

COM Yardage: 1½ yds. - price @ GR 1      Weight: 20 lbs  
 Items Per Carton: 2

# Classic Stools



## 215 - 46

### Features

30" H x 15" W x 15" D  
 Revolving Seat  
 1" Pulled Seat  
 1" Rd. Steel Tubing (16 Gauge)  
 #11 Acrylic Glide  
 #18 Swivel

**Chrome Only**

### 30" Seat Height

Quantity	Grade 1	Grade 2	Grade 3	Grade 4	Grade 5
7+	224.99	231.26	237.71	244.35	251.21
1-6	290.43	297.33	304.40	311.73	319.25

COM Yardage: 1/3 yd. - price @ GR 1

Weight: 25 lbs

Items Per Carton: 1

Seat Diameter: 14"



## 215 - 125 R

### Features

30" H x 15" W x 15" D  
 Revolving Seat  
 1" Pulled Seat  
 1" Rd. Steel Tubing (16 Gauge)  
 #11 Acrylic Glide  
 #18 Swivel

**Chrome Only**

### 30" Seat Height

Quantity	Grade 1	Grade 2	Grade 3	Grade 4	Grade 5
7+	208.85	215.13	221.56	228.20	235.05
1-6	272.67	279.57	286.67	293.97	301.50

COM Yardage: 2/3 yd. - price @ GR 1

Weight: 25 lbs

Items Per Carton: 1

Seat Diameter: 14"



## 215 - 125 RB

### Features

43" H x 15" W x 15" D  
 30" Seat Height Only  
 Revolving Seat  
 1" Pulled Seat  
 1" Rd. Steel Tubing (16 Gauge)  
 #11 Acrylic Glide  
 #18 Swivel

**Chrome Only**

### 30" Seat Height

Quantity	Grade 1	Grade 2	Grade 3	Grade 4	Grade 5
7+	341.31	351.20	361.37	371.85	382.62
1-6	418.39	429.27	440.43	451.97	463.81

COM Yardage: 7/8 yd. - price @ GR 1

Weight: 30 lbs

Items Per Carton: 1

Seat Diameter: 14"



## 215 - 530

### Features

43" H x 15" W x 15" D  
 30" Seat Height Only  
 Revolving Seat  
 1" Pulled Seat  
 1" Rd. Steel Tubing (16 Gauge)  
 #11 Acrylic Glide  
 #20 DBL Plate Swivel

**Chrome Only**

### 30" Seat Height

Quantity	Grade 1	Grade 2	Grade 3	Grade 4	Grade 5
7+	291.12	299.49	308.12	316.98	326.13
1-6	363.17	372.38	381.85	391.61	401.68

COM Yardage: 3/4 yd. - price @ GR 1

Weight: 30 lbs

Items Per Carton: 1

Seat Width: 15"

## Chrome Finish Only & Revolving Seats



### 215 - 531 SH

#### Features

43" H x 15" W x 15" D  
30" Seat Height Only  
Revolving Seat  
2" Sewn Seat  
1" Rd. Steel Tubing (16 Gauge)  
#11 Acrylic Glide  
#20 DBL Plate Swivel  
Chrome Frame Only

#### 30" Seat Height

Quantity	Grade 1	Grade 2	Grade 3	Grade 4	Grade 5
7+	298.68	307.29	316.14	325.25	334.64
1-6	371.51	380.98	394.20	400.71	411.05

COM Yardage: ¾ yd. - price @ GR 1

Weight: 27 lbs

Items Per Carton: 1

Seat Width: 15"



### 215 - 782/49 NS

#### Features

30" H x 15" W x 15" D  
Revolving Seat  
Black & Red Stripe at No Cost  
#18 Swivel  
Chrome Frame Only

#### Optional:

Custom Color Stripes (See pg. 98)

#### 30" Seat Height

Quantity	Grade 1	Grade 2	Grade 3	Grade 4	Grade 5
7+	216.73	222.76	228.82	235.37	241.92
1-6	281.34	287.97	294.81	301.84	309.07

COM Yardage: ½ yd. - price @ GR 1

Weight: 25 lbs

Items Per Carton: 1

Seat Diameter: 14"



### 215 - 782 RB/49 NSRB 30" Seat Height

#### Features

43" H x 15" W x 15" D  
30" Seat Height Only  
Revolving Seat  
Black & Red Stripe at No Cost  
#18 Swivel  
Chrome Frame Only

#### Optional:

Custom Color Stripes (See pg. 98)

Quantity	Grade 1	Grade 2	Grade 3	Grade 4	Grade 5
7+	332.29	341.42	350.83	360.50	370.47
1-6	408.47	418.49	428.84	439.47	450.47

COM Yardage: ¾ yd. - price @ GR 1

Weight: 30 lbs

Items Per Carton: 1

Seat Diameter: 14"



### 215 - 921

#### Features

43" H x 15" W x 15" D  
30" Seat Height Only  
Revolving Seat  
1" Pulled Seat  
1" Rd. Steel Tubing (16 Gauge)  
#11 Acrylic Glide  
#20 DBL Plate Swivel  
Chrome Frame Only

#### 30" Seat Height

Quantity	Grade 1	Grade 2	Grade 3	Grade 4	Grade 5
7+	291.12	299.49	308.12	316.98	326.13
1-6	363.17	372.38	381.85	391.61	401.68

COM Yardage: ¾ yd. - price @ GR 1

Weight: 30 lbs

Items Per Carton: 1

Seat Width: 15"

## Chrome Finish Only & Revolving Seats



*Scalloped Ring Stool*

### 250 - 49 NS

#### Features

30" H x 16" W x 16" D  
 Revolving Seat  
 1" Pulled Seat  
 1¼" Rd. Steel Tubing (16 Gauge)  
 #15 Glide  
 #18 Swivel

#### 30" Seat Height Only

Quantity	Grade 1	Grade 2	Grade 3	Grade 4	Grade 5
7+	423.64	434.41	445.51	456.94	468.75
1-6	508.92	520.78	533.01	545.94	558.55

COM Yardage: ⅓ yd. - price @ GR 1

Weight: 25lbs

Items Per Carton: 1

Seat Diameter: 14"



*Scalloped Ring Stool with Back*

### 250 - 49 NSRB

#### Features

43" H x 16" W x 16" D  
 Revolving Seat  
 1" Pulled Seat  
 1¼" Rd. Steel Tubing (16 Gauge)  
 #15 Glide  
 #18 Swivel

#### 30" Seat Height Only

Quantity	Grade 1	Grade 2	Grade 3	Grade 4	Grade 5
7+	530.81	544.44	558.49	572.96	587.85
1-6	626.82	641.83	657.27	673.18	689.56

COM Yardage: ⅔ yd. - price @ GR 1

Weight: 30lbs

Items Per Carton: 1

Seat Diameter: 14"



*Bulged Ring Stool*

### 250 - 781/46

#### Features

30" H x 16" W x 16" D  
 Revolving Seat  
 1" Pulled Seat  
 1¼" Rd. Steel Tubing (16 Gauge)  
 #15 Glide  
 #18 Swivel

#### 30" Seat Height Only

Quantity	Grade 1	Grade 2	Grade 3	Grade 4	Grade 5
7+	387.28	396.98	406.96	417.25	427.86
1-6	468.95	479.61	490.58	501.91	513.57

COM Yardage: ⅓ yd. - price @ GR 1

Weight: 21lbs

Items Per Carton: 1

Seat Diameter: 13"



*Grooved Ring Stool*

### 250 - 782

#### Features

30" H x 16" W x 16" D  
 Revolving Seat  
 1¼" Rd. Steel Tubing (16 Gauge)  
 Black & Red Stripe at No Cost  
 #18 Swivel

#### 30" Seat Height Only

Quantity	Grade 1	Grade 2	Grade 3	Grade 4	Grade 5
7+	423.64	434.41	445.51	456.94	468.75
1-6	508.92	520.78	533.01	545.59	558.55

COM Yardage: ⅓ yd. - price @ GR 1

Weight: 25lbs

Items Per Carton: 1

Seat Diameter: 14"

#### Optional:

Custom Color Stripes (See pg. 98)



**Grooved Ring  
Stool with Back**

## 250 - 782 RB

### Features

43" H x 16" W x 16" D  
 Revolving Seat  
 1¼" Rd. Steel Tubing (16 Gauge)  
 #15 Glide  
 Black & Red Stripe at No Cost  
 #18 Swivel

### Optional:

Custom Color Stripes (See pg. 98)

### 30" Seat Height Only

Quantity	Grade 1	Grade 2	Grade 3	Grade 4	Grade 5
7+	530.81	544.44	558.49	572.96	587.85
1 - 6	626.82	641.83	657.27	673.18	689.56

COM Yardage: ¾ yd. - price @ GR 1

Weight: 30 lbs

Items Per Carton: 1

Seat Diameter: 14"



**Button Back Stool**

## 250 - 921 BB

### Features

43" H x 16" W x 16" D  
 Revolving Seat  
 1" Pulled Seat  
 1¼" Rd. Steel Tubing (16 Gauge)  
 #15 Glide  
 #20 DBL Plate Swivel

### Optional:

2" Waterfall or Sewn Hood Seat (Add 27.61)

### 30" Seat Height Only

Quantity	Grade 1	Grade 2	Grade 3	Grade 4	Grade 5
7+	498.48	511.64	525.18	539.11	553.47
1 - 6	591.27	605.73	620.63	635.97	651.74

COM Yardage: ¾ yd. - price @ GR 1

Weight: 29 lbs

Items Per Carton: 1

Seat Width: 15"



**Malibu Channel  
Back Stool**

## 250 - 921 MB

### Features

43" H x 16" W x 16" D  
 Revolving Seat  
 1" Pulled Seat  
 1¼" Rd. Steel Tubing (16 Gauge)  
 #15 Glide  
 #20 DBL Plate Swivel

### Optional:

2" Waterfall or Sewn Hood Seat (Add 27.61)

### 30" Seat Height Only

Quantity	Grade 1	Grade 2	Grade 3	Grade 4	Grade 5
7+	498.48	511.64	525.18	539.11	553.47
1 - 6	591.27	605.73	620.63	635.97	651.74

COM Yardage: ¾ yd. - price @ GR 1

Weight: 29 lbs

Items Per Carton: 1

Seat Width: 15"



**"V"  
Back Stool**

## 250 - 921 "V"

### Features

43" H x 16" W x 16" D  
 Revolving Seat  
 1" Pulled Seat  
 1¼" Rd. Steel Tubing (16 Gauge)  
 #15 Glide  
 #20 DBL Plate Swivel

### Optional:

2" Waterfall or Sewn Hood Seat (Add 27.61)

### 30" Seat Height Only

Quantity	Grade 1	Grade 2	Grade 3	Grade 4	Grade 5
7+	498.48	511.64	525.18	539.11	553.47
1 - 6	591.27	605.73	620.63	635.97	651.74

COM Yardage: ¾ yd. - price @ GR 1

Weight: 29 lbs

Items Per Carton: 1

Seat Width: 15"

## Standard Chrome Finish & Revolving Seats



Scalloped Ring Stool  
with Back

### 264 - 49 NSRB

#### Features

43" H x 16" W x 16" D  
1" Rd. Steel Tubing (16 Gauge)  
#11 Acrylic Glide  
#19 with Cup Swivel

#### Optional:

Add 27.38 for Standard Paint  
24" Seat Height at No Cost

#### 30" Seat Height

Quantity	Grade 1	Grade 2	Grade 3	Grade 4	Grade 5
7+	381.67	392.29	403.22	414.46	426.06
1-6	462.79	474.46	486.48	498.84	511.58

COM Yardage: 2/3 yd. - price @ GR 1

Weight: 30lbs

Items Per Carton: 1

Seat Diameter: 14"



Single Ring  
Stool

### 264 - 125

#### Features

30" H x 16" W x 16" D  
1" Pulled Seat  
1" Rd. Steel Tubing (16 Gauge)  
#11 Acrylic Glide  
#801 Swivel

#### Optional:

Add 27.38 for Standard Paint  
24" Seat Height at No Cost

#### 30" Seat Height

Quantity	Grade 1	Grade 2	Grade 3	Grade 4	Grade 5
7+	268.94	276.68	284.63	292.84	301.30
1-6	338.78	347.29	356.08	365.09	374.36

COM Yardage: 2/3 yd. - price @ GR 1

Weight: 21lbs

Items Per Carton: 1

Seat Diameter: 14"



Single Ring  
Drum Stool

### 264 - 161

#### Features

30" H x 16" W x 16" D  
1" Pulled Seat  
1" Rd. Steel Tubing (16 Gauge)  
#11 Acrylic Glide  
#801 Swivel

#### Optional:

Add 27.38 for Standard Paint  
24" Seat Height at No Cost

#### 30" Seat Height

Quantity	Grade 1	Grade 2	Grade 3	Grade 4	Grade 5
7+	297.84	306.44	315.29	324.41	333.82
1-6	370.55	380.01	389.76	399.79	410.13

COM Yardage: 1 yd. - price @ GR 1

Weight: 22lbs

Items Per Carton: 1

Seat Diameter: 14"



Single Ring Stool  
with Back

### 264 - 530

#### Features

43" H x 16" W x 16" D  
1" Pulled Seat  
1" Rd. Steel Tubing (16 Gauge)  
#11 Acrylic Glide  
#21 with Cup Swivel

#### Optional:

Add 27.38 for Standard Paint  
24" Seat Height at No Cost

#### 30" Seat Height

Quantity	Grade 1	Grade 2	Grade 3	Grade 4	Grade 5
7+	345.21	355.21	365.52	376.11	387.01
1-6	422.68	433.67	445.01	456.66	468.66

COM Yardage: 2/3 yd. - price @ GR 1

Weight: 29lbs

Items Per Carton: 1

Seat Width: 15"

## Standard Chrome Finish & Revolving Seats



**Bulged Single Ring Stool**

### 264 - 781/46

#### Features

30" H x 16" W x 16" D  
1" Pulled Seat  
1" Rd. Steel Tubing (16 Gauge)  
#11 Acrylic Glide  
#801 Swivel

#### Optional:

Add 27.38 for Standard Paint  
24" Seat Height at No Cost

### 30" Seat Height

Quantity	Grade 1	Grade 2	Grade 3	Grade 4	Grade 5
7+	264.04	271.51	279.16	287.08	295.21
1 - 6	333.40	341.58	349.99	358.69	367.66

COM Yardage: 1/3 yd. - price @ GR 1

Weight: 21 lbs

Items Per Carton: 1

Seat Diameter: 13"



**Grooved Ring Stool**

### 264 - 782/49 NS

#### Features

30" H x 16" W x 16" D  
Black & Red Stripe at No Cost  
#801 Swivel

#### Optional:

Custom Color Stripes (See pg.98)  
Add 27.38 for Standard Paint  
24" Seat Height at No Cost

### 30" Seat Height

Quantity	Grade 1	Grade 2	Grade 3	Grade 4	Grade 5
7+	267.01	274.56	282.30	290.30	298.53
1 - 6	336.65	344.94	353.46	362.25	371.33

COM Yardage: 1/3 yd. - price @ GR 1

Weight: 22 lbs

Items Per Carton: 1

Seat Diameter: 14"



**Grooved Ring Stool with Back**

### 264 - 782 RB

#### Features

43" H x 16" W x 16" D  
Black & Red Stripe at No Cost  
#19 with Cup Swivel

#### Optional:

Custom Color Stripes (See pg.98)  
Add 27.38 for Standard Paint  
24" Seat Height at No Cost

### 30" Seat Height

Quantity	Grade 1	Grade 2	Grade 3	Grade 4	Grade 5
7+	381.21	392.29	403.22	414.46	426.06
1 - 6	462.79	474.46	486.48	498.84	511.58

COM Yardage: 2/3 yd. - price @ GR 1

Weight: 30 lbs

Items Per Carton: 1

Seat Diameter: 14"



**Single Ring Stool with Back**

### 264 - 921

#### Features

43" H x 16" W x 16" D  
1" Pulled Seat  
1" Rd. Steel Tubing (16 Gauge)  
#11 Acrylic Glide  
#21 with Cup Swivel

#### Optional:

Add 27.38 for Standard Paint  
24" Seat Height at No Cost

### 30" Seat Height

Quantity	Grade 1	Grade 2	Grade 3	Grade 4	Grade 5
7+	345.21	355.21	365.52	376.11	387.01
1 - 6	422.68	433.67	445.01	456.66	468.66

COM Yardage: 2/3 yd. - price @ GR 1

Weight: 29 lbs

Items Per Carton: 1

Seat Width: 15"

# Standard Chrome Footring



*Tapered Leg Stool*

## 265 - 125 R

### Features

30" H x 16" W x 16" D  
#3 Platform glide  
#18 Swivel

### 30" Seat Height

Quantity	Grade 1	Grade 2	Grade 3	Grade 4	Grade 5
7+	217.53	224.09	230.80	237.73	244.87
1-6	282.24	289.45	296.82	304.45	312.29

COM Yardage:  $\frac{2}{3}$  yd. - price @ GR 1

Weight: 22 lbs

Items Per Carton: 1

Seat Diameter: 14"



*Tapered Leg Stool  
with Back*

## 265 - 125 RB

### Features

43" H x 16" W x 16" D  
30" Seat Height Only  
#3 Platform Glide  
#18 Swivel

### 30" Seat Height

Quantity	Grade 1	Grade 2	Grade 3	Grade 4	Grade 5
7+	323.58	333.28	343.29	353.59	364.19
1-6	398.87	409.56	420.56	431.88	443.55

COM Yardage:  $\frac{7}{8}$  yd. - price @ GR 1

Weight: 27 lbs

Items Per Carton: 1

Seat Diameter: 14"



*Tapered Leg Stool  
Fully Upholstered*

## 265 - 242 WF

### Features

43" H x 16" W x 16" D  
30" Seat Height Only  
2" Waterfall Seat  
#3 Platform Glide  
#20 DBL Plate Swivel

### 30" Seat Height

Quantity	Grade 1	Grade 2	Grade 3	Grade 4	Grade 5
7+	340.99	351.21	361.75	372.62	383.79
1-6	418.02	429.29	440.88	452.80	465.11

COM Yardage: 1 $\frac{1}{4}$  yds. - price @ GR 1

Weight: 27 lbs

Items Per Carton: 1

Seat Width: 16"



*Tapered Leg Stool  
with Straight Back*

## 265 - X23

### Features

43" H x 16" W x 16" D  
30" Seat Height Only  
#3 Platform Glide  
#20 DBL Plate Swivel

### 30" Seat Height

Quantity	Grade 1	Grade 2	Grade 3	Grade 4	Grade 5
7+	206.51	212.72	219.08	225.66	232.44
1-6	269.26	276.08	283.09	290.33	297.77

COM Yardage:  $\frac{2}{3}$  yd. - price @ GR 1

Weight: 28 lb

Items Per Carton: 1

Seat Width: 14"

Frames Are Standard Satin Black



**100 - 242 WF**

**Features**

- 43" H x 16" W x 16" D
- 3½" Column (No Chrome)
- #20 DBL Plate Swivel
- 1¼" Steel Base plate (No Chrome)
- Chrome Footring Standard

**Optional:**

- 24" Seat Height at No Cost

Quantity	Grade 1	Grade 2	Grade 3	Grade 4	Grade 5
7+	577.47	591.71	606.33	621.39	636.93
1-6	677.30	692.95	709.06	725.62	742.72

COM Yardage: 1¼ yd. - price @ GR 1

Weight: 37 lbs

Items Per Carton: 1

Seat Width: 16"



Econo Stool

**752 Econo**

**Features**

- 30" H x 16" W x 16" D
- 1" Pulled Seat
- 1³⁄₁₆" Sq. Steel Tubing (16 Gauge)
- #2 Glide
- Standard Chrome

**Optional:**

- 24" Seat Height at No Cost

**30" Seat Height**

Quantity	Grade 1	Grade 2	Grade 3	Grade 4	Grade 5
7+	190.99	195.66	200.49	205.45	210.59
1-6	252.16	257.31	262.62	268.09	273.73

COM Yardage: ⅓ yd. - price @ GR 1

Weight: 16 lbs

Items Per Carton: 1

Seat Diameter: 13"



Econo Stool

**751 Econo**

**Features**

- 30" H x 16" W x 16" D
- 1" Pulled Seat
- 1³⁄₁₆" Sq. Steel Tubing (16 Gauge)
- #2 Glide
- Standard Chrome

**Optional:**

- 24" Seat Height at No Cost

**30" Seat Height**

Quantity	Grade 1	Grade 2	Grade 3	Grade 4	Grade 5
7+	185.97	190.49	195.15	199.98	204.92
1-6	246.65	251.63	256.77	262.08	267.51

COM Yardage: ⅓ yd. - price @ GR 1

Weight: 16 lbs

Items Per Carton: 1

Seat Diameter: 13"

## Standard Chrome Finish & Revolving Seats



**Arch Leg Stool with Scalloped Seat Ring**

### 300 - 49 NS/782

#### Features

30" H x 16" W x 16" D  
 3½" Column  
 1" Rd. Steel Tubing (16 Gauge)  
 #6 Glide  
 #801 Swivel

#### Optional:

24" Seat Height at No Cost

### 30" Seat Height

Quantity	Grade 1	Grade 2	Grade 3	Grade 4	Grade 5
7+	383.24	393.59	404.28	415.25	426.62
1 - 6	464.48	475.89	487.64	499.73	512.21

COM Yardage: ⅓ yd. - price @ GR 1

Weight: 22lbs

Items Per Carton: 1

Seat Diameter: 14"



**Arch Leg Stool with Scalloped Seat Ring with Back**

### 300 - 49 NSRB/782 RB 30" Seat Height

#### Features

43" H x 16" W x 16" D  
 3½" Column  
 1" Rd. Steel Tubing (16 Gauge)  
 #6 Glide  
 #19 with Cup Swivel

#### Optional:

24" Seat Height at No Cost

Quantity	Grade 1	Grade 2	Grade 3	Grade 4	Grade 5
7+	490.33	503.55	517.17	531.17	545.61
1 - 6	582.30	596.83	611.82	627.24	643.11

COM Yardage: ⅔ yd. - price @ GR 1

Weight: 30lbs

Items Per Carton: 1

Seat Diameter: 14"



**Arch Leg Stool with Drum Seat**

### 300 - 161

#### Features

30" H x 16" W x 16" D  
 3½" Column  
 1" Rd. Steel Tubing (16 Gauge)  
 #6 Glide  
 #801 Swivel

#### Optional:

Accent Piping (Shown Here)

24" Seat Height at No Cost

### 30" Seat Height

Quantity	Grade 1	Grade 2	Grade 3	Grade 4	Grade 5
7+	377.42	388.06	399.07	410.39	422.07
1 - 6	458.10	469.81	481.91	494.37	507.21

COM Yardage: 1 yd. - price @ GR 1

Weight: 29lbs

Items Per Carton: 1

Seat Diameter: 14"



**Arch Leg Stool with Back**

### 300 - 531 SH

#### Features

43" H x 16" W x 16" D  
 2" Sewn Hood Seat  
 3½" Column  
 1" Rd. Steel Tubing (16 Gauge)  
 #6 Glide  
 #21 with Cup Swivel

#### Optional:

Accent Piping (Shown Here)

24" Seat Height at No Cost

### 30" Seat Height

Quantity	Grade 1	Grade 2	Grade 3	Grade 4	Grade 5
7+	450.03	462.52	475.38	488.63	502.28
1 - 6	537.98	551.72	565.85	580.43	595.44

COM Yardage: ¾ yd. - price @ GR 1

Weight: 29lbs

Items Per Carton: 1

Seat Width: 15"

## Standard Chrome Finish & Revolving Seats



**Arch Leg Stool with  
Bulged Seat Ring**

### 300 - 781/46

#### Features

30" H x 16" W x 16" D  
3½" Column  
1" Pulled Seat  
1" Rd. Steel Tubing (16 Gauge)  
#6 Glide  
#801 Swivel

#### Optional:

24" Seat Height at No Cost

#### 30" Seat Height

Quantity	Grade 1	Grade 2	Grade 3	Grade 4	Grade 5
7+	360.74	370.44	380.41	390.69	401.31
1-6	439.76	450.42	461.39	472.73	484.35

COM Yardage: ⅓ yd. - price @ GR 1

Weight: 22 lbs

Items Per Carton: 1

Seat Diameter: 13"



**Arch Leg Stool  
with Back**

### 300 - 921 / 530

#### Features

43" H x 16" W x 16" D  
3½" Column  
1" Pulled Seat  
1" Rd. Steel Tubing (16 Gauge)  
#6 Glide  
#21 Swivel with Cup

#### Optional:

24" Seat Height at No Cost

#### 30" Seat Height

Quantity	Grade 1	Grade 2	Grade 3	Grade 4	Grade 5
7+	433.30	445.28	457.64	470.34	483.41
1-6	519.56	532.74	546.32	560.32	574.71

COM Yardage: ⅔ yd. - price @ GR 1

Weight: 29 lbs

Items Per Carton: 1

Seat Width: 15"



**Arch Leg Stool with  
"V" Back**

### 300 - 921 "V"

#### Features

43" H x 16" W x 16" D  
3½" Column  
1" Pulled Seat  
1" Rd. Steel Tubing (16 Gauge)  
#6 Glide  
#21 Swivel with Cup

#### Optional:

24" Seat Height at No Cost

#### 30" Seat Height

Quantity	Grade 1	Grade 2	Grade 3	Grade 4	Grade 5
7+	471.93	485.09	498.61	512.56	526.92
1-6	562.07	576.51	591.41	606.77	622.55

COM Yardage: 1 yd. - price @ GR 1

Weight: 29 lbs

Items Per Carton: 1

Seat Width: 15"



**Arch Leg Stool with  
Channel Back**

### 300 - 939 CB

#### Features

43" H x 16" W x 16" D  
3½" Column  
1" Pulled Seat  
1" Rd. Steel Tubing (16 Gauge)  
#6 Glide  
#21 Swivel with Cup

#### Optional:

24" Seat Height at No Cost

#### 30" Seat Height

Quantity	Grade 1	Grade 2	Grade 3	Grade 4	Grade 5
7+	457.69	470.41	483.50	496.99	510.88
1-6	546.40	560.40	574.78	589.62	604.92

COM Yardage: ¾ yd. - price @ GR 1

Weight: 29 lbs

Items Per Carton: 1

Seat Width: 15"

# Standard Chrome Finish, Revolving Seats, All Paints Available



Single Ring Pyramid  
Base Stool

## 400 - 49 NS

### Features

30" H x 16" W x 16" D  
1" Pulled Seat  
1¼" Rd. Tubing (16 Gauge)  
#15 Glide  
#18 Swivel

### 30" Seat Height Only

Quantity	Grade 1	Grade 2	Grade 3	Grade 4	Grade 5
7+	315.13	322.67	330.42	338.42	346.65
1-6	389.59	397.88	406.40	415.20	424.26

COM Yardage: ⅓ yd. - price @ GR 1  
Items Per Carton: 1

Weight: 23 lbs  
Seat Diameter: 14"



Single Ring Pyramid Base  
with Back Stool

## 400 - 49 NSRB

### Features

43" H x 16" W x 16" D  
1" Pulled Seat  
1¼" Rd. Tubing (16 Gauge)  
#15 Glide  
#18 Swivel

### 30" Seat Height Only

Quantity	Grade 1	Grade 2	Grade 3	Grade 4	Grade 5
7+	429.80	440.44	451.35	462.59	474.19
1-6	515.73	527.39	539.41	551.79	564.56

COM Yardage: ¾ yd. - price @ GR 1  
Items Per Carton: 1

Weight: 30 lbs  
Seat Diameter: 14"



Single Ring Pyramid  
Base Stool

## 400 - 125

### Features

30" H x 16" W x 16" D  
1" Pulled Seat  
1¼" Rd. Tubing (16 Gauge)  
#15 Glide  
#18 Swivel

### 30" Seat Height Only

Quantity	Grade 1	Grade 2	Grade 3	Grade 4	Grade 5
7+	305.92	313.66	321.62	329.83	338.28
1-6	379.46	387.97	396.72	405.74	415.05

COM Yardage: ⅔ yd. - price @ GR 1  
Items Per Carton: 1

Weight: 23 lbs  
Seat Diameter: 14"



Single Ring Pyramid  
Stool with Back

## 400 - 242 WF

### Features

43" H x 16" W x 16" D  
2" Waterfall Seat  
1¼" Rd. Tubing (16 Gauge)  
#15 Glide  
#20 DBL Plate Swivel

### 30" Seat Height Only

Quantity	Grade 1	Grade 2	Grade 3	Grade 4	Grade 5
7+	441.61	453.43	465.62	478.12	491.00
1-6	528.71	541.73	555.11	568.88	583.05

COM Yardage: 1¼ yds. - price @ GR 1  
Items Per Carton: 1

Weight: 37 lbs  
Seat Width: 16"

## Standard Chrome Finish, Revolving Seats, All Paints Available



Single Ring Pyramid Base  
with Bulged Seat Ring

### 400 - 781/46

#### Features

30" H x 16" W x 16" D  
1" Pulled Seat  
1¼" Rd. Steel Tubing (16 Gauge)  
#15 Glide  
#18 Swivel

#### 30" Seat Height Only

Quantity	Grade 1	Grade 2	Grade 3	Grade 4	Grade 5
7+	312.16	319.61	327.28	335.17	343.33
1-6	386.32	394.51	402.93	411.63	420.58

COM Yardage: ⅓ yd. - price @ GR 1

Weight: 23 lbs

Items Per Carton: 1

Seat Diameter: 13"



Single Ring Pyramid Base  
with Grooved Ring

### 400 - 782

#### Features

30" H x 16" W x 16" D  
1¼" Rd. Steel Tubing (16 Gauge)  
Black & Red Stripe at No Cost  
#15 Glide  
#18 Swivel

#### Optional:

Custom Color Stripes (See pg.98)

#### 30" Seat Height Only

Quantity	Grade 1	Grade 2	Grade 3	Grade 4	Grade 5
7+	315.13	322.67	330.42	338.42	346.65
1-6	389.59	397.88	406.40	415.20	424.26

COM Yardage: ⅓ yd. - price @ GR 1

Weight: 23 lbs

Items Per Carton: 1

Seat Diameter: 14"



Single Ring Pyramid Base  
with Malibu Back

### 400 - 782 RBMB

#### Features

43" H x 16" W x 16" D  
1¼" Rd. Steel Tubing (16 Gauge)  
Black & Red Stripe at No Cost  
#15 Glide  
#18 Swivel

#### Optional:

Custom Color Stripes (See pg.98)

#### 30" Seat Height Only

Quantity	Grade 1	Grade 2	Grade 3	Grade 4	Grade 5
7+	468.40	480.14	492.28	504.73	517.60
1-6	558.16	571.09	584.43	598.15	612.29

COM Yardage: ¾ yd. - price @ GR 1

Weight: 30 lbs

Items Per Carton: 1

Seat Diameter: 14"



Single Ring Pyramid Base  
with Handle Back

### 400 - 921 HB

#### Features

43" H x 16" W x 16" D  
1¼" Rd. Steel Tubing (16 Gauge)  
#15 Glide  
#20 Swivel

#### 30" Seat Height Only

Quantity	Grade 1	Grade 2	Grade 3	Grade 4	Grade 5
7+	466.63	478.82	491.37	504.29	517.61
1-6	556.22	569.11	583.45	597.65	612.31

COM Yardage: ¾ yd. - price @ GR 1

Weight: 30 lbs

Items Per Carton: 1

Seat Width: 15"

## Standard Black Base Bottom & Revolving Seats



### 500 - 46

#### Features

30" H x 16" W x 16" D  
3 1/2" Column  
#801 Swivel

#### Optional:

Add 78.32 for Chrome (Shown Here)  
24" Seat Height at No Cost

#### 30" Seat Height

Quantity	Grade 1	Grade 2	Grade 3	Grade 4	Grade 5
7+	395.94	406.55	417.44	428.67	440.21
1-6	478.48	490.12	502.11	514.47	527.17

COM Yardage: 1/3 yd. - price @ GR 1

Weight: 30lbs

Items Per Carton: 1

Seat Diameter: 14"



### 500 - 125

#### Features

30" H x 16" W x 16" D  
3 1/2" Column  
#801 Swivel

#### Optional:

Add 78.32 for Chrome  
24" Seat Height at No Cost

#### 30" Seat Height

Quantity	Grade 1	Grade 2	Grade 3	Grade 4	Grade 5
7+	360.53	370.99	381.72	392.81	404.23
1-6	439.50	451.00	462.83	475.03	487.58

COM Yardage: 2/3 yd. - price @ GR 1

Weight: 30lbs

Items Per Carton: 1

Seat Diameter: 14"



### 500 - 161

#### Features

30" H x 16" W x 16" D  
3 1/2" Column  
#801 Swivel

#### Optional:

Add 78.32 for Chrome  
24" Seat Height at No Cost

#### 30" Seat Height

Quantity	Grade 1	Grade 2	Grade 3	Grade 4	Grade 5
7+	394.75	406.22	418.06	430.23	442.77
1-6	477.17	489.80	502.79	516.19	529.98

COM Yardage: 1 yd. - price @ GR 1

Weight: 30lbs

Items Per Carton: 1

Seat Diameter: 14"



### 500 - 242 WF

#### Features

43" H x 16" W x 16" D  
3 1/2" Column  
#20 DBL Plate Swivel

#### Optional:

Add 78.32 for Chrome  
24" Seat Height at No Cost

#### 30" Seat Height

Quantity	Grade 1	Grade 2	Grade 3	Grade 4	Grade 5
7+	495.42	509.94	524.86	540.23	556.07
1-6	587.89	603.86	620.28	637.17	654.62

COM Yardage: 1 1/4 yds. - price @ GR 1

Weight: 37lbs

Items Per Carton: 1

Seat Width: 16"

## Standard Black Base Bottom & Revolving Seats



### 500 - 781

#### Features

30" H x 16" W x 16" D

3½" Column

#801 Swivel

#### Optional:

Add 78.32 for Chrome

24" Seat Height at No Cost

#### 30" Seat Height

Quantity	Grade 1	Grade 2	Grade 3	Grade 4	Grade 5
7+	395.94	406.55	417.44	428.67	440.21
1 - 6	478.48	490.12	502.11	514.47	527.17

COM Yardage: ⅓ yd. - price @ GR 1

Weight: 30 lb

Items Per Carton: 1

Seat Diameter: 13"



### 500 - 782

#### Features

30" H x 16" W x 16" D

3½" Column

Black & Red Stripe at No Cost

#801 Swivel

#### Optional:

Custom Color Stripes (See pg.98)

Add 78.32 for Chrome (Shown Here)

24" Seat Height at No Cost

#### 30" Seat Height

Quantity	Grade 1	Grade 2	Grade 3	Grade 4	Grade 5
7+	397.70	408.34	419.28	430.56	442.18
1 - 6	480.41	492.11	504.15	516.56	529.35

COM Yardage: ⅓ yd. - price @ GR 1

Weight: 30 lb

Items Per Carton: 1

Seat Diameter: 14"



### 500 - 782 RB

#### Features

43" H x 16" W x 16" D

3½" Column

Black & Red Stripe at No Cost

#19 with Cup Swivel

#### Optional:

Custom Color Stripes (See pg.98)

Add 78.32 for Chrome (Shown Here)

24" Seat Height at No Cost

#### 30" Seat Height

Quantity	Grade 1	Grade 2	Grade 3	Grade 4	Grade 5
7+	503.37	516.81	530.65	544.89	559.58
1 - 6	596.63	611.43	626.66	642.32	658.46

COM Yardage: ⅔ yd. - price @ GR 1

Weight: 37 lb

Items Per Carton: 1

Seat Diameter: 14"



### 500 - 921

#### Features

43" H x 16" W x 16" D

3½" Column

#21 with Cup Swivel

#### Optional:

Add 78.32 for Chrome (Shown Here)

24" Seat Height at No Cost

#### 30" Seat Height

Quantity	Grade 1	Grade 2	Grade 3	Grade 4	Grade 5
7+	443.69	456.35	469.32	482.65	496.41
1 - 6	531.10	544.91	559.19	573.85	588.98

COM Yardage: ⅔ yd. - price @ GR 1

Weight: 37 lb

Items Per Carton: 1

Seat Width: 15"

# Typical Counter Stool Position

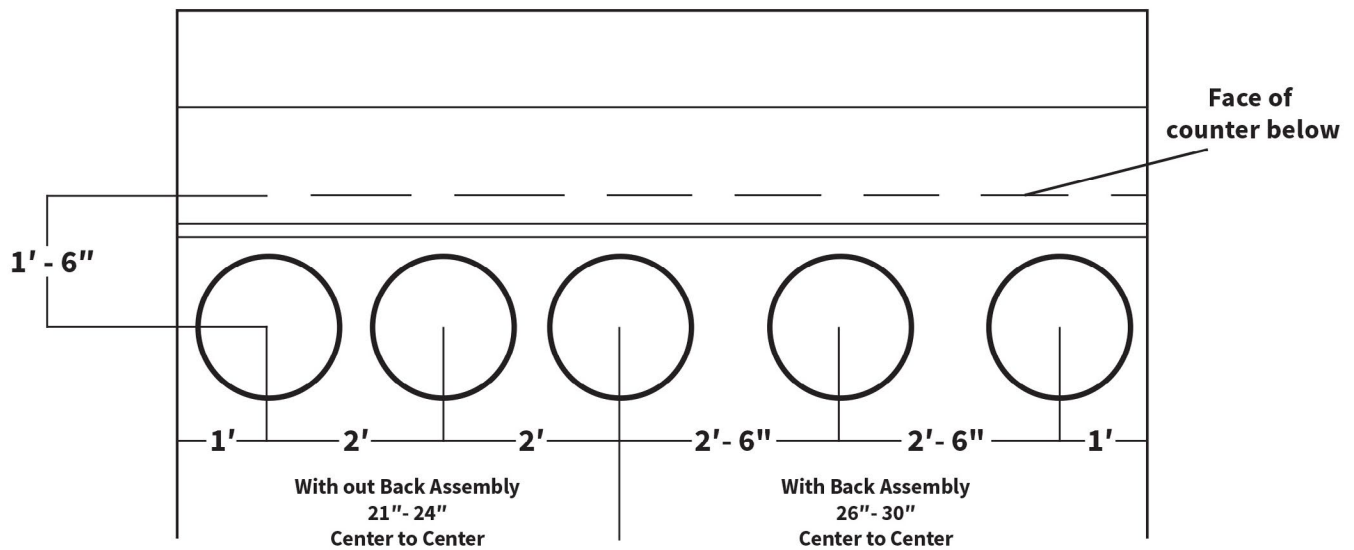

## TYPICAL COUNTER PLAN

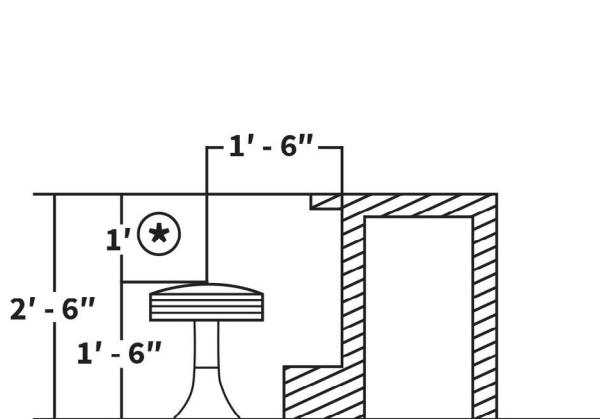

## TYPICAL 30" COUNTER SECTION

★ - 12" Dimension should be held to maintain correct spatial relationships

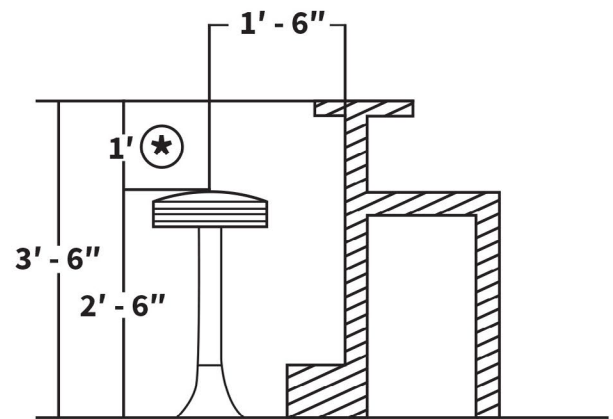

## TYPICAL 42" COUNTER SECTION

★ - 12" Dimension should be held to maintain correct spatial relationships

## Standard Chrome Finish & Revolving Seats

\*Specify The Floor Attachment Shown On Pg.105



Classic Fountain Stool

### 1500 - 46

#### Features

30" H x 14" W x 14" D  
3½" Column  
9" Bell Bottom  
#801 Swivel

#### Optional:

Grooved Column (Shown Here: Add 36.17)

#### Specify: 18", 24", or 30" Seat Height

Quantity	Grade 1	Grade 2	Grade 3	Grade 4	Grade 5
7+	357.91	367.68	377.75	388.14	398.80
1-6	436.64	447.38	458.46	469.88	481.60

COM Yardage: ⅓ yd. - price @ GR 1

Items Per Carton: Varies

Weight: 25 lb

Seat Diameter: 14"



Classic Fountain Stool  
with Drum Seat

### 1500 - 161

#### Features

30" H x 14" W x 14" D  
3½" Column  
9" Bell Bottom  
#801 Swivel

#### Specify: 18", 24", or 30" Seat Height

Quantity	Grade 1	Grade 2	Grade 3	Grade 4	Grade 5
7+	379.65	390.56	401.78	413.35	425.28
1-6	460.54	472.55	484.89	497.62	510.74

COM Yardage: 1 yd. - price @ GR 1

Items Per Carton: Varies

Weight: 19 lb

Seat Diameter: 14"



Classic Fountain Stool  
with Back

### 1500 - 530

#### Features

43" H x 15" W x 15" D  
3½" Column  
9" Bell Bottom  
#22 with Cup Return Swivel

#### Specify: 18", 24", or 30" Seat Height

Quantity	Grade 1	Grade 2	Grade 3	Grade 4	Grade 5
7+	421.39	433.19	445.32	457.82	470.68
1-6	506.47	519.43	532.79	546.53	560.70

COM Yardage: ¾ yd. - price @ GR 1

Items Per Carton: 1

Weight: 25 lb

Seat Width: 15"



Classic Fountain Stool  
with Bulged Seat Ring

### 1500 - 781

#### Features

43" H x 13" W x 13" D  
3½" Column  
9" Bell Bottom  
#801 Swivel

#### Optional:

Footrest (Shown with 606: Add 157.97)

#### Specify: 18", 24", or 30" Seat Height

Quantity	Grade 1	Grade 2	Grade 3	Grade 4	Grade 5
7+	357.94	367.74	377.79	388.16	398.86
1-6	436.69	447.44	458.54	469.93	481.66

COM Yardage: ⅓ yd. - price @ GR 1

Items Per Carton: 1

Weight: 25 lb

Seat Diameter: 13"

\*Footrest not available on 18"

## Standard Chrome Finish & Revolving Seats

\*Specify The Floor Attachment Shown On Pg.105



Classic Fountain Stool  
with Grooved Seat Ring

### 1500 - 782

#### Features

30" H x 14" W x 14" D  
3½" Column  
9" Bell Bottom  
Black & Red Stripe at No Cost  
#801 Swivel

#### Optional:

Custom Color Stripes (See pg.98)

#### Specify : 18", 24", or 30" Seat Height

Quantity	Grade 1	Grade 2	Grade 3	Grade 4	Grade 5
7+	361.21	371.08	381.22	391.74	402.50
1 - 6	440.25	451.11	462.29	473.82	485.69

COM Yardage: ⅓ yd. - price @ GR 1  
Items Per Carton: Varies

Weight: 25lb  
Seat Diameter: 14"



Classic Fountain Stool  
with Back & Grooved  
Seat Ring

### 1500 - 782 RB

#### Features

43" H x 14" W x 14" D  
3½" Column  
9" Bell Bottom  
Black & Red Stripe at No Cost  
#19 with Cup Return Swivel

#### Optional:

Custom Color Stripes (See pg. 98)

#### Specify : 18", 24", or 30" Seat Height

Quantity	Grade 1	Grade 2	Grade 3	Grade 4	Grade 5
7+	483.64	496.80	510.39	524.37	538.76
1 - 6	574.94	589.42	604.37	619.74	635.57

COM Yardage: ⅔ yd. - price @ GR 1  
Items Per Carton: Varies

Weight: 30lb  
Seat Diameter: 14"



Classic Fountain Stool  
with Back

### 1500 - 921

#### Features

43" H x 15" W x 15" D  
3½" Column  
9" Bell Bottom  
#22 with Cup Return Swivel

#### Optional:

Footrest (Shown with 505: Add 157.97)

\*Footrest not available on 18"

#### Specify : 18", 24", or 30" Seat Height

Quantity	Grade 1	Grade 2	Grade 3	Grade 4	Grade 5
7+	421.39	433.19	445.32	457.82	470.68
1 - 6	506.47	519.43	532.79	546.53	560.70

COM Yardage: ¾ yd. - price @ GR 1  
Items Per Carton: 1

Weight: 25lb  
Seat Width: 15"



Classic Fountain Stool  
with Channel Back

### 1500 - 939 CB

#### Features

43" H x 15" W x 15" D  
3½" Column  
9" Bell Bottom  
#22 with Cup Return Swivel

#### Specify : 18", 24", or 30" Seat Height

Quantity	Grade 1	Grade 2	Grade 3	Grade 4	Grade 5
7+	462.44	475.47	488.88	502.71	516.92
1 - 6	551.64	565.96	580.71	595.89	611.55

COM Yardage: 1 yd. - price @ GR 1  
Items Per Carton: Varies

Weight: 26lb  
Seat Width: 15"

## Standard Chrome Finish & Revolving Seats

\* Standard Red & Black Teardrop Colors

\* Specify The Floor Attachment Shown On Pg.105



Classic Teardrop Stool  
with Smooth Ring

### 1700 - 46

#### Features

30" H x 14" W x 14" D  
3 1/2" Column  
9" Bell Bottom  
#801 Swivel

#### Optional:

Grooved Column (Shown Here: Add 36.17)

#### Specify: 18", 24", or 30" Seat Height

Quantity	Grade 1	Grade 2	Grade 3	Grade 4	Grade 5
7+	385.66	396.28	407.21	418.46	430.06
1-6	467.17	478.86	490.88	503.24	515.98

COM Yardage: 1/3 yd. - price @ GR 1

Weight: 18 lbs

Items Per Carton: Varies

Seat Diameter: 14"



Classic Teardrop Stool  
with Drum Seat

### 1700 - 161

#### Features

30" H x 14" W x 14" D  
3 1/2" Column  
9" Bell Bottom  
#801 Swivel

#### Specify: 18", 24", or 30" Seat Height

Quantity	Grade 1	Grade 2	Grade 3	Grade 4	Grade 5
7+	407.46	419.22	431.31	443.77	456.59
1-6	491.17	504.09	517.38	531.09	545.19

COM Yardage: 1 yd. - price @ GR 1

Weight: 19 lbs

Items Per Carton: 1

Seat Diameter: 14"



Classic Teardrop Stool  
with Bulged Seat Ring

### 1700 - 781

#### Features

30" H x 13" W x 13" D  
3 1/2" Column  
9" Bell Bottom  
#801 Swivel

#### Optional:

Footrest (Shown is 606: Add 157.97)

\*Footrest not available on 18"

#### Specify: 18", 24", or 30" Seat Height

Quantity	Grade 1	Grade 2	Grade 3	Grade 4	Grade 5
7+	385.70	396.31	407.26	418.50	430.08
1-6	467.22	478.89	490.91	503.28	516.03

COM Yardage: 1/3 yd. - price @ GR 1

Weight: 22 lbs

Items Per Carton: Varies

Seat Diameter: 13"



Classic Teardrop Stool  
with Grooved Seat Ring

### 1700 - 782

#### Features

30" H x 14" W x 14" D  
3 1/2" Column  
9" Bell Bottom  
Black & Red Stripe at No Cost  
#801 Swivel

#### Optional:

Custom Color Stripes (See pg.98)

#### Specify: 18", 24", or 30" Seat Height

Quantity	Grade 1	Grade 2	Grade 3	Grade 4	Grade 5
7+	381.46	399.79	410.81	422.17	433.86
1-6	470.93	482.70	494.82	507.32	520.18

COM Yardage: 1/3 yd. - price @ GR 1

Weight: 25 lbs

Items Per Carton: Varies

Seat Diameter: 14"

# Standard Chrome Finish & Revolving Seats

\* Standard Red & Black Teardrop Colors

\* Specify The Floor Attachment Shown On Pg.105



Classic Teardrop Stool with Elite Back & Grooved Seat Ring

## 1700 - 782 RB - EL

### Features

- 43" H x 14" W x 14" D
- 3½" Column
- 9" Bell Bottom
- Black & Red Stripe at No Cost
- #19 SR Swivel

### Optional:

Custom Color Stripes (See Below)

### Specify: 18", 24", or 30" Seat Height

Quantity	Grade 1	Grade 2	Grade 3	Grade 4	Grade 5
7+	550.06	564.06	578.51	593.38	608.67
1-6	648.02	663.41	679.31	695.65	712.49

COM Yardage: ⅔ yd. - price @ GR 1

Weight: 30lbs

Items Per Carton: Varies

Seat Diameter: 14"



Classic Teardrop Stool with Smooth Back

## 1700 - 921

### Features

- 43" H x 15" W x 15" D
- 3½" Column
- 9" Bell Bottom
- #22 with Cup Return Swivel

### Optional:

Grooved Column (Shown Here: Add 36.17)

### Specify: 18", 24", or 30" Seat Height

Quantity	Grade 1	Grade 2	Grade 3	Grade 4	Grade 5
7+	449.19	461.79	474.81	488.19	502.00
1-6	537.03	550.91	564.96	579.94	595.13

COM Yardage: ⅔ yd. - price @ GR 1

Weight: 30lbs

Items Per Carton: Varies

Seat Width: 15"



Classic Teardrop Stool with "V" Back

## 1700 - 921 "V"

### Features

- 43" H x 15" W x 15" D
- 3½" Column
- 9" Bell Bottom
- #22 with Cup Return Swivel

### Optional:

Grooved Column (Shown Here: Add 36.17)

### Specify: 18", 24", or 30" Seat Height

Quantity	Grade 1	Grade 2	Grade 3	Grade 4	Grade 5
7+	487.90	501.68	515.89	530.50	545.56
1-6	579.63	594.80	610.42	626.49	643.06

COM Yardage: ¼ yd. - price @ GR 1

Weight: 30lbs

Items Per Carton: 1

Seat Width: 15"

## Custom 1700 Features

### Special Heights

33.15

### Custom Color Pinstriping

5+ pcs: 24.28 each

### Grooved Columns

36.17

### Teardrop Colors

Red and black are standard

Available In all powder paint colors



## Standard Paint Finish

\*Footrest not available on 18" Seat Height

\*Specify The Floor Attachment Shown On Pg.105

**1800 - INN - 2120 BS****Features**

41" H x 17" W x 18" D  
 1¼" Pulled Seat  
 3" Sq. Column w/ Cast Iron Bottom  
 #22 DBL Plate Seat Return Swivel

**Optional:**

¾" Wood Seat (Add 98.82 Grade 1)  
 18", 24", or 30" Seat Height  
 Paint Only Footrest (Shown is 606: Add 157.97)

\*Footrest not available on 18"

Quantity	Grade 1	Grade 2	Grade 3	Grade 4	Grade 5
7+	586.43	592.01	597.60	603.20	608.78
1 - 6	686.08	692.21	698.35	704.50	710.63

COM Yardage: ½ yd. - price @ GR 1  
 Items Per Carton: Varies

Weight: 36 lbs, Wood 38 lbs  
 Specify Floor Attachment:  
 Type B (Wood)  
 Type C (Concrete)

**1800 - INN - 2220 BS****Features**

41" H x 17" W x 18" D  
 1¼" Pulled Seat  
 3" Sq. Column w/ Cast Iron Bottom  
 #22 DBL Plate Seat Return Swivel

**Optional:**

¾" Wood Seat (Add 98.82 Grade 1)  
 18", 24", or 30" Seat Height  
 Paint Only Footrest (Shown is 606: Add 157.97)

\*Footrest not available on 18"

Quantity	Grade 1	Grade 2	Grade 3	Grade 4	Grade 5
7+	535.63	541.23	546.83	552.40	557.99
1 - 6	630.19	636.34	642.48	648.61	654.76

COM Yardage: ½ yd. - price @ GR 1  
 Items Per Carton: Varies

Weight: 36 lbs, Wood 38 lbs  
 Specify Floor Attachment:  
 Type B (Wood)  
 Type C (Concrete)

**1800 - INN - 2320 BS****Features**

41" H x 17" W x 18" D  
 1¼" Pulled Seat  
 3" Sq. Column w/ Cast Iron Bottom  
 #22 DBL Plate Seat Return Swivel

**Optional:**

¾" Wood Seat (Add 98.82 Grade 1)  
 18", 24", or 30" Seat Height  
 Paint Only Footrest (Shown is 606: Add 157.97)

\*Footrest not available on 18"

Quantity	Grade 1	Grade 2	Grade 3	Grade 4	Grade 5
7+	569.26	574.85	580.44	586.03	591.60
1 - 6	667.20	673.32	679.46	685.62	691.74

COM Yardage: ½ yd. - price @ GR 1  
 Items Per Carton: Varies

Weight: 36 lbs, Wood 38 lbs  
 Specify Floor Attachment:  
 Type B (Wood)  
 Type C (Concrete)

**1800 - INN - 2420 BS****Features**

41" H x 17" W x 18" D  
 1¼" Pulled Seat  
 3" Sq. Column w/ Cast Iron Bottom  
 #22 DBL Plate Seat Return Swivel

**Optional:**

¾" Wood Seat (Add 98.82 Grade 1)  
 18", 24", or 30" Seat Height  
 Paint Only Footrest (Shown is 606: Add 157.97)

\*Footrest not available on 18"

Quantity	Grade 1	Grade 2	Grade 3	Grade 4	Grade 5
7+	535.65	541.23	546.83	552.40	557.99
1 - 6	630.19	636.34	642.49	648.62	654.76

COM Yardage: ½ yd. - price @ GR 1  
 Items Per Carton: Varies

Weight: 36 lbs, Wood 38 lbs  
 Specify Floor Attachment:  
 Type B (Wood)  
 Type C (Concrete)

## Standard Paint Finish

\*Footrest not available on 18" Seat Height

\*Specify The Floor Attachment Shown On Pg.105

**1800 - INN - 2520 BS****Features**

41" H x 17" W x 18" D  
 1¼" Pulled Seat  
 3" Sq. Column w/ Cast Iron Bottom  
 #22 DBL Plate Seat Return Swivel

**Optional:**

¾" Wood Seat (Add 98.81 Grade 1)  
 18", 24", or 30" Seat Height  
 Paint Only Footrest (Shown is 606: Add 157.97)

\*Footrest not available on 18"

Quantity	Grade 1	Grade 2	Grade 3	Grade 4	Grade 5
7+	535.65	541.23	546.83	552.40	557.99
1 - 6	630.19	636.34	642.49	648.62	654.76

COM Yardage: ½ yd. - price @ GR 1

Items Per Carton: Varies

Weight: 36 lbs, Wood 38 lbs

Specify Floor Attachment:

Type B (Wood)

Type C (Concrete)

**1800 - INN - 2620 BS****Features**

41" H x 17" W x 18" D  
 1¼" Pulled Seat  
 3" Sq. Column w/ Cast Iron Bottom  
 #22 DBL Plate Seat Return Swivel

**Optional:**

¾" Wood Seat (Add 98.81 Grade 1)  
 18", 24", or 30" Seat Height  
 Paint Only Footrest (Shown is 606: Add 157.97)

\*Footrest not available on 18"

Quantity	Grade 1	Grade 2	Grade 3	Grade 4	Grade 5
7+	547.39	552.99	558.56	564.14	569.73
1 - 6	643.10	649.25	655.39	661.53	667.67

COM Yardage: ½ yd. - price @ GR 1

Items Per Carton: Varies

Weight: 36 lbs, Wood 38 lbs

Specify Floor Attachment:

Type B (Wood)

Type C (Concrete)

**1800 - LSC - 250 BS****Features**

41" H x 17" W x 18" D  
 1¼" Pulled Seat  
 3" Sq. Column w/ Cast Iron Bottom  
 #22 DBL Plate Seat Return Swivel

**Optional:**

¾" Wood Seat (Add 98.81 Grade 1)  
 18", 24", or 30" Seat Height  
 Paint Only Footrest (Shown is 606: Add 157.97)

\*Footrest not available on 18"

Quantity	Grade 1	Grade 2	Grade 3	Grade 4	Grade 5
7+	558.24	564.09	569.93	575.79	581.63
1 - 6	657.00	663.42	669.79	676.30	682.73

COM Yardage: ½ yd. - price @ GR 1

Items Per Carton: Varies

Weight: 36 lbs, Wood 38 lbs

Specify Floor Attachment:

Type B (Wood)

Type C (Concrete)

**1800 - LSC - 350 BS****Features**

41" H x 17" W x 18" D  
 1¼" Pulled Seat  
 3" Sq. Column w/ Cast Iron Bottom  
 #22 DBL Plate Seat Return Swivel

**Optional:**

¾" Wood Seat (Add 98.81 Grade 1)  
 18", 24", or 30" Seat Height  
 Paint Only Footrest (Shown is 606: Add 157.97)

\*Footrest not available on 18"

Quantity	Grade 1	Grade 2	Grade 3	Grade 4	Grade 5
7+	566.77	572.62	578.47	584.32	590.18
1 - 6	666.41	672.82	679.25	685.69	692.14

COM Yardage: ½ yd. - price @ GR 1

Items Per Carton: Varies

Weight: 36 lbs, Wood 38 lbs

Specify Floor Attachment:

Type B (Wood)

Type C (Concrete)

## Standard Paint Finish

\*Footrest not available on 18" Seat Height

\*Specify The Floor Attachment Shown On Pg.105

**1800 - LSC - 450 BS****Features**

41" H x 17" W x 18" D  
 1¼" Pulled Seat  
 3" Sq. Column w/ Cast Iron Bottom  
 #22 DBL Plate Seat Return Swivel

**Optional:**

¾" Wood Seat (Add 98.81 Grade 1)  
 18", 24", or 30" Seat Height  
 Paint Only Footrest (Shown is 606: Add 157.97)

\*Footrest not available on 18"

Quantity	Grade 1	Grade 2	Grade 3	Grade 4	Grade 5
7+	566.77	572.62	578.47	584.32	590.18
1-6	666.41	672.82	679.25	685.71	692.14

COM Yardage: ½ yd. - price @ GR 1

Items Per Carton: Varies

Weight: 36 lbs, Wood 38 lbs

Specify Floor Attachment:

Type B (Wood)

Type C (Concrete)

**1800 - LSC - 475 BS****Features**

41" H x 17" W x 18" D  
 1¼" Pulled Seat  
 3" Sq. Column w/ Cast Iron Bottom  
 #22 DBL Plate Seat Return Swivel

**Optional:**

¾" Wood Seat (Add 98.81 Grade 1)  
 18", 24", or 30" Seat Height  
 Paint Only Footrest (Shown on pg. 106)  
 (Add 157.97)

\*Footrest not available on 18"

Quantity	Grade 1	Grade 2	Grade 3	Grade 4	Grade 5
7+	566.77	572.62	578.47	584.32	590.18
1-6	666.41	672.82	679.25	685.71	692.14

COM Yardage: ½ yd. - price @ GR 1

Items Per Carton: Varies

Weight: 36 lbs, Wood 38 lbs

Specify Floor Attachment:

Type B (Wood)

Type C (Concrete)

**1800 - LSC - 501 BS****Features**

41" H x 17" W x 18" D  
 1¼" Pulled Seat  
 3" Sq. Column w/ Cast Iron Bottom  
 #22 DBL Plate Seat Return Swivel

**Optional:**

¾" Wood Seat (Add 98.81 Grade 1)  
 18", 24", or 30" Seat Height  
 Paint Only Footrest (Shown is 606: Add 157.97)

\*Footrest not available on 18"

Quantity	Grade 1	Grade 2	Grade 3	Grade 4	Grade 5
7+	609.76	615.60	621.47	627.31	633.16
1-6	713.68	720.11	726.55	732.98	739.43

COM Yardage: ½ yd. - price @ GR 1

Items Per Carton: Varies

Weight: 36 lbs, Wood 38 lbs

Specify Floor Attachment:

Type B (Wood)

Type C (Concrete)

**1800 - LSC - 550 BS****Features**

41" H x 17" W x 18" D  
 1¼" Pulled Seat  
 3" Sq. Column w/ Cast Iron Bottom  
 #22 DBL Plate Seat Return Swivel

**Optional:**

¾" Wood Seat (Add 98.81 Grade 1)  
 18", 24", or 30" Seat Height  
 Paint Only Footrest (Shown is 606: Add 157.97)

\*Footrest not available on 18"

Quantity	Grade 1	Grade 2	Grade 3	Grade 4	Grade 5
7+	609.76	615.60	621.47	627.31	633.16
1-6	713.68	720.11	726.55	732.98	739.43

COM Yardage: ½ yd. - price @ GR 1

Items Per Carton: Varies

Weight: 36 lbs, Wood 38 lbs

Specify Floor Attachment:

Type B (Wood)

Type C (Concrete)

## Standard Paint Finish

\*Footrest not available on 18" Seat Height

\*Specify The Floor Attachment Shown On Pg.105

**1800 - LSC - 575 BS****Features**

41" H x 17" W x 18" D  
 1¼" Pulled Seat  
 3" Sq. Column w/ Cast Iron Bottom  
 #22 DBL Plate Seat Return Swivel

**Optional:**

¾" Wood Seat (Add 98.81 Grade 1)  
 18", 24", or 30" Seat Height  
 Paint Only Footrest (Shown is 606: Add 157.97)

\*Footrest not available on 18"

Quantity	Grade 1	Grade 2	Grade 3	Grade 4	Grade 5
7+	609.76	615.60	621.47	627.31	633.16
1-6	713.68	720.11	726.55	732.98	739.43

COM Yardage: ½ yd. - price @ GR 1

Items Per Carton: Varies

Weight: 36 lbs, Wood 38 lbs

Specify Floor Attachment:

Type B (Wood)

Type C (Concrete)

**1800 - LSC - 600 BS****Features**

41" H x 17" W x 18" D  
 1¼" Pulled Seat  
 3" Sq. Column w/ Cast Iron Bottom  
 #22 DBL Plate Seat Return Swivel

**Optional:**

¾" Wood Seat (Add 98.81 Grade 1)  
 18", 24", or 30" Seat Height  
 Paint Only Footrest (Shown is 606: Add 157.97)

\*Footrest not available on 18"

Quantity	Grade 1	Grade 2	Grade 3	Grade 4	Grade 5
7+	609.76	615.60	621.47	627.31	633.16
1-6	713.68	720.11	726.55	732.98	739.43

COM Yardage: ½ yd. - price @ GR 1

Items Per Carton: Varies

Weight: 36 lbs, Wood 38 lbs

Specify Floor Attachment:

Type B (Wood)

Type C (Concrete)

**1800 - LSC - 650 BS****Features**

41" H x 17" W x 18" D  
 1¼" Pulled Seat  
 3" Sq. Column w/ Cast Iron Bottom  
 #22 DBL Plate Seat Return Swivel

**Optional:**

¾" Wood Seat (Add 98.81 Grade 1)  
 18", 24", or 30" Seat Height  
 Paint Only Footrest (Shown is 606: Add 157.97)

\*Footrest not available on 18"

Quantity	Grade 1	Grade 2	Grade 3	Grade 4	Grade 5
7+	575.99	581.84	587.71	593.54	599.41
1-6	676.54	682.96	689.42	695.84	702.28

COM Yardage: ½ yd. - price @ GR 1

Items Per Carton: Varies

Weight: 36 lbs, Wood 38 lbs

Specify Floor Attachment:

Type B (Wood)

Type C (Concrete)

**1800 - LSC - 750 BS****Features**

41" H x 17" W x 18" D  
 1¼" Pulled Seat  
 3" Sq. Column w/ Cast Iron Bottom  
 #22 DBL Plate Seat Return Swivel

**Optional:**

¾" Wood Seat (Add 98.81 Grade 1)  
 18", 24", or 30" Seat Height  
 Paint Only Footrest (Shown is 606: Add 157.97)

\*Footrest not available on 18"

Quantity	Grade 1	Grade 2	Grade 3	Grade 4	Grade 5
7+	567.22	573.07	578.92	584.75	590.61
1-6	666.86	673.30	679.73	686.18	692.61

COM Yardage: ½ yd. - price @ GR 1

Items Per Carton: Varies

Weight: 36 lbs, Wood 38 lbs

Specify Floor Attachment:

Type B (Wood)

Type C (Concrete)

## Standard Paint Finish

\*Footrest not available on 18" Seat Height

\*Specify The Floor Attachment Shown On Pg.105

**1800 - OX - 10 BS****Features**

44" H x 17" W x 18" D  
 1¼" Pulled Seat  
 3" Sq. Column w/ Cast Iron Bottom  
 #22 DBL Plate Seat Return Swivel

**Optional:**

18", 24", or 30" Seat Height  
 Paint Only Footrest (Shown is 606: Add 157.97)

\*Footrest not available on 18"

Quantity	Grade 1	Grade 2	Grade 3	Grade 4	Grade 5
7+	680.56	686.44	692.26	698.12	703.97
1 - 6	791.55	798.01	804.44	810.87	817.32

COM Yardage: 1⅓ yds. - price @ GR 1

Items Per Carton: Varies

Weight: 36 lbs, Wood 38 lbs

Specify Floor Attachment:

Type B (Wood)

Type C (Concrete)

**1800 - OX - 20 BS****Features**

45" H x 17" W x 18" D  
 1¼" Pulled Seat  
 3" Sq. Column w/ Cast Iron Bottom  
 #22 DBL Plate Seat Return Swivel

**Optional:**

18", 24", or 30" Seat Height  
 Paint Only Footrest (Shown is 606: Add 157.97)

\*Footrest not available on 18"

Quantity	Grade 1	Grade 2	Grade 3	Grade 4	Grade 5
7+	680.56	686.44	692.26	698.12	703.97
1 - 6	791.55	798.01	804.44	810.87	817.32

COM Yardage: 1⅓ yds. - price @ GR 1

Items Per Carton: Varies

Weight: 36 lbs, Wood 38 lbs

Specify Floor Attachment:

Type B (Wood)

Type C (Concrete)

**1800 - OX - 30 BS****Features**

44" H x 17" W x 18" D  
 1¼" Pulled Seat  
 3" Sq. Column w/ Cast Iron Bottom  
 #22 DBL Plate Seat Return Swivel

**Optional:**

18", 24", or 30" Seat Height  
 Paint Only Footrest (Shown on pg. 106)  
 (Add 157.97)

\*Footrest not available on 18"

Quantity	Grade 1	Grade 2	Grade 3	Grade 4	Grade 5
7+	680.56	686.44	692.26	698.12	703.97
1 - 6	791.55	798.01	804.44	810.87	817.32

COM Yardage: 1⅓ yds. - price @ GR 1

Items Per Carton: Varies

Weight: 36 lbs, Wood 38 lbs

Specify Floor Attachment:

Type B (Wood)

Type C (Concrete)

**1800 - OX - 40 BS****Features**

43" H x 17" W x 18" D  
 1¼" Pulled Seat  
 3" Sq. Column w/ Cast Iron Bottom  
 #22 DBL Plate Seat Return Swivel

**Optional:**

18", 24", or 30" Seat Height  
 Paint Only Footrest (Shown on pg. 106)  
 (Add 157.97)

\*Footrest not available on 18"

Quantity	Grade 1	Grade 2	Grade 3	Grade 4	Grade 5
7+	603.29	609.13	614.98	620.83	626.69
1 - 6	706.52	712.99	719.40	725.84	732.28

COM Yardage: 1⅓ yds. - price @ GR 1

Items Per Carton: Varies

Weight: 36 lbs, Wood 38 lbs

Specify Floor Attachment:

Type B (Wood)

Type C (Concrete)

## Standard Paint Finish

\*Footrest not available on 18" Seat Height

\*Specify The Floor Attachment Shown On Pg.105

**1800 - OX - 50 BS****Features**

44" H x 17" W x 18" D  
 1¼" Pulled Seat  
 3" Sq. Column w/ Cast Iron Bottom  
 #22 DBL Plate Seat Return Swivel

**Optional:**

18", 24", or 30" Seat Height  
 Paint Only Footrest (Shown is 606: Add 157.97)

\*Footrest not available on 18"

Quantity	Grade 1	Grade 2	Grade 3	Grade 4	Grade 5
7+	603.29	609.13	614.98	620.83	626.69
1-6	706.52	712.99	719.40	725.84	732.28

COM Yardage: 1½ yds. - price @ GR 1

Items Per Carton: Varies

Weight: 36 lbs, Wood 38 lbs

Specify Floor Attachment:

Type B (Wood)

Type C (Concrete)

**1800 - OX - 60 BS****Features**

41" H x 17" W x 18" D  
 1¼" Pulled Seat  
 3" Sq. Column w/ Cast Iron Bottom  
 #22 DBL Plate Seat Return Swivel

**Optional:**

18", 24", or 30" Seat Height  
 Paint Only Footrest (Shown on pg. 106)

(Add 154.87)

\*Footrest not available on 18"

Quantity	Grade 1	Grade 2	Grade 3	Grade 4	Grade 5
7+	603.29	609.13	614.98	620.83	626.69
1-6	706.52	712.99	719.40	725.84	732.28

COM Yardage: 1 yd. - price @ GR 1

Items Per Carton: Varies

Weight: 36 lbs, Wood 38 lbs

Specify Floor Attachment:

Type B (Wood)

Type C (Concrete)

# 1500/1700/1800 Attachments

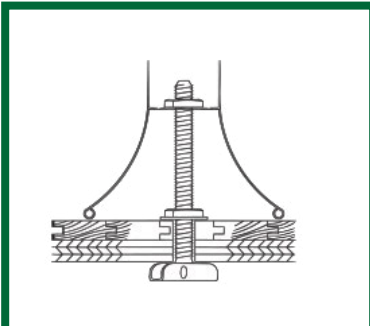

Type "A"

## Type "A" Floor Attachment

Utilized to secure the 1500 - 1700 series fountain stool or H - Series Table Base through a wooden floor (*Floor not to exceed 5" in thickness*) by means of a toggle bolt.

39.45

*With purchase of stool*

FREE

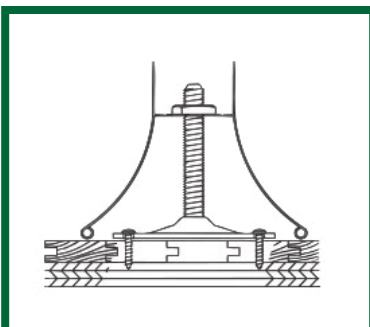

Type "B"

## Type "B" Floor Attachment

Utilized to secure the 1500 /1700/1800 series fountain stool or H - series table base to a wooden floor by means of an anchor plate.

39.45

*With purchase of stool*

FREE

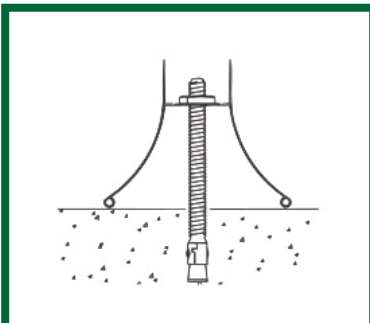

Type "C"

## Type "C" Floor Attachment

Utilized to secure the 1500 /1700/1800 series fountain stool or H - series table base into a composite floor by means of an expansion shell.

39.45

*With purchase of stool*

FREE

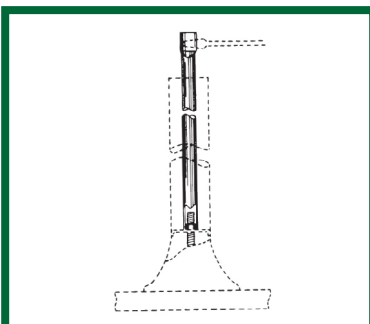

Wrench

## Wrench Floor Attachment

Utilized to tighten the 1500 - 1700 series fountain stool or H - Series Table Base to the floor.

39.45

*With purchase of stool*

FREE

# Footrest

\*Footrest Not Available On 18" Stools



1500 Base

## 1500 Chrome Stool Base Only

18", 24", or 30" seat height. Swivel, floor attachment, and wrench are not included.

246.12



404 Footring

## 404 Footring

Brings the contemporary styling of the 500 series to the 1500 & 1700 series fountain stool. Chrome finish is standard.

16" ring

223.80



505 Footrest

## 505 Footrest

Offers a triangular, contoured cast version to the 1500 & 1700 soda fountain stool.

157.97



606 Footrest

## 606 Footrest

Displays an attractive, inexpensive addition to the 1500 & 1700 soda fountain series along with 1800 base stools. 1800 stool base footrest are painted only.

157.97



707 Footrest

## 707 Footrest

Displays an inexpensive, nostalgic addition to the 1500 - 1700 series fountain stool.

157.97







# Glides

**Please note:** Over the years, some models may have changed from one glide style to another. When requesting replacement glides for your particular situation, compare the glide that you currently have with our illustrations. Should your glide look different than one of those illustrated please feel free to call the factory toll free @ 1-800-325-7093.

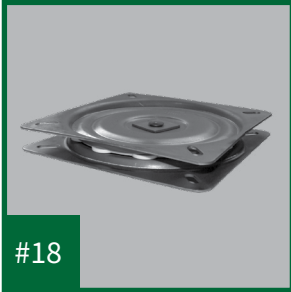
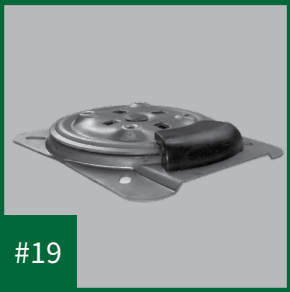
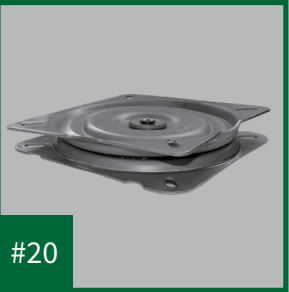
<p><b>Stack Chair</b></p>  <p>#1</p> <p>5.33</p>	<p><b>Stack Chair</b></p>  <p>#2</p> <p>3.77</p>	<p><b>265 &amp; 921</b></p>  <p>#3</p> <p>6.02</p>	<p><b>921,934,300</b></p>  <p>#6</p> <p>5.33</p>	<p><b>A &amp; D Bases / 500 Stools</b></p>  <p>#7</p> <p>5.33</p>
<p><b>Metal Glide</b> 1<sup>3</sup>/<sub>16</sub>" or 1" Square <i>Nylon bottom available on 1<sup>3</sup>/<sub>16</sub>"</i></p>	<p><b>Plastic Glide</b> 1<sup>3</sup>/<sub>16</sub>" Square</p>	<p><b>Metal Glide</b> 3/4" and 1" Round</p>	<p><b>Metal Glide</b> 1" Round</p>	<p><b>Metal Glide/Nylon</b> Adjustable 1<sup>1</sup>/<sub>16</sub>" Diameter 1/4-20 Thread</p>
<p><b>All Bases</b></p>  <p>#9 <i>Self Leveling</i></p> <p>14.38</p>	<p><b>B &amp; C Bases</b></p>  <p>#10</p> <p>3.77</p>	<p><b>264 &amp; 215</b></p>  <p>#11</p> <p>3.77</p>	<p><b>Nylon Parlor</b></p>  <p>#13</p> <p>3.77</p>	<p><b>Omni &amp; Spectrum</b></p>  <p>#15</p> <p>6.27</p>
<p><b>Plastic Glide</b> 1<sup>3</sup>/<sub>16</sub>" Diameter 1/4-20 thread</p>	<p><b>Plastic Glide</b> Adjustable 1" Diameter 1/4-20 thread</p>	<p><b>Black Acrylic Glide</b> 1" Diameter for 16 gauge</p>	<p><b>Nylon Glide</b> 7/8" Round platform</p>	<p><b>Metal Glide/Nylon</b> 1<sup>1</sup>/<sub>4</sub>" Round</p>
<p><b>LSC, INN, OX</b></p>  <p>#18</p> <p>3.77</p>	<p><b>Glide Cap</b></p>  <p>#1-6</p> <p>3.14</p>	<p><b>884</b></p>  <p>#17</p> <p>3.77</p>	<p><b>885</b></p>  <p>#16</p> <p>3.14</p>	
<p><b>Butyrate Glide</b> 1<sup>1</sup>/<sub>4</sub>" Square</p>	<p><b>Retread Heavy Duty Nylon</b></p>			

# Swivels

**Please note:** Over the years, some models may have changed from one swivel style to another. When requesting replacement swivels for your particular situation, compare the swivel that you currently have with our illustrations. Should your swivel look different than one of those illustrated please feel free to call the factory toll free @ 1-800-325-7093.

<p>215,265, 1800 Stool</p>  <p>#18</p> <p>46.25</p> <p>Double - plate, flat swivel for seat without backs.</p>	<p>Call Factory</p>  <p>#19</p> <p>53.08</p> <p>Single - plate, flat swivel.</p>	<p>215 &amp; 265</p>  <p>#20</p> <p>46.25</p> <p>Double - plate, 3° tilting swivel.</p>	<p>300,264,1500 &amp; 1700</p>  <p>#21 cup</p> <p>53.08</p> <p>Single - plate, 3° tilting swivel with cup.</p>
<p>1500 - 1700 Stools w/ Backs</p>  <p>#22 studs</p> <p>81.45</p> <p>Single - plate, 3° tilting, return swivel with studs.</p>	<p>1500 - 1700 Stools w/ Backs</p>  <p>#22 cup</p> <p>81.45</p> <p>Single - plate, 3° tilting, return swivel with cup.</p>	<p>1800 Stools</p>  <p>#22 DP</p> <p>81.45</p> <p>Double - plate, 3° tilting, return swivel with double plate.</p>	<p>264,300,1500 &amp; 1700 Stools</p>  <p>#801</p> <p>53.08</p> <p>Flat swivel, with cup.</p>



Swivel, 3 bolt pattern



Swivel, 4 bolt pattern

# Modular Series



### M2W

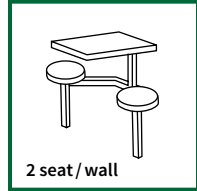

Includes 2 seat unit with 24x24 table top

Specify upholstery:  
Up to grade 3

Specify upper finish:  
Any Vitro powder coat

Specify lower finish:  
Satin black standard, or Vitro powder coat

Specify:  
Bolt down or core drill

### M4W

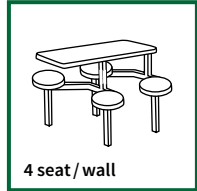

Includes 4 seat unit with 24x48 table top

Specify upholstery:  
Up to grade 3

Specify upper finish:  
Any Vitro powder coat

Specify lower finish:  
Satin black standard, or Vitro powder coat

Specify:  
Bolt down or core drill

### M4I

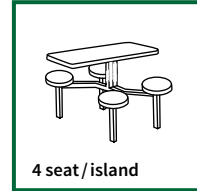

Includes 4 seat unit with 24x48 table top

Specify upholstery:  
Up to grade 3

Specify upper finish:  
Any Vitro powder coat

Specify lower finish:  
Satin black standard, or Vitro powder coat

Specify:  
Bolt down or core drill

### M6W

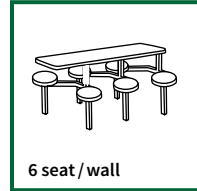

Includes 6 seat unit with 24x76 table top

Specify upholstery:  
Up to grade 3

Specify upper finish:  
Any Vitro powder coat

Specify lower finish:  
Satin black standard, or Vitro powder coat

Specify:  
Bolt down or core drill



With Table Top <i>Specify: BN or BGA-125</i>	With Table Top <i>Specify: BN or BGA-125</i>	With Table Top <i>Specify: BN or BGA-125</i>	With Table Top <i>Specify: BN or BGA-125</i>
1364.34	2694.40	2657.64	3999.80
Without Table 1231.22	Without Table 2428.23	Without Table 2324.94	Without Table 3467.86



With Table Top <i>Specify: BN or BGA-125</i>	With Table Top <i>Specify: BN or BGA-125</i>	With Table Top <i>Specify: BN or BGA-125</i>	With Table Top <i>Specify: BN or BGA-125</i>
1364.34	2694.40	2605.53	3921.37
Without Table 1231.22	Without Table 2428.23	Without Table 2324.94	Without Table 3467.86

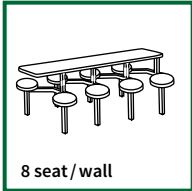
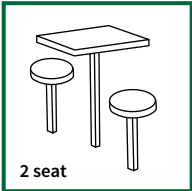
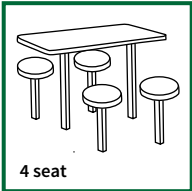

With Table Top <i>Specify: BN or BGA-125</i>	With Table Top <i>Specify: BN or BGA-125</i>	With Table Top <i>Specify: BN or BGA-125</i>	With Table Top <i>Specify: BN or BGA-125</i>
1364.34	2694.40	2605.53	3921.37
Without Table 1231.22	Without Table 2428.23	Without Table 2324.94	Without Table 3467.86

M8W	M2P	M4P
		
8 seat / wall	2 seat	4 seat
<p><b>Includes 8 seat unit with 24x102 table top</b></p> <p>Specify upholstery: <i>Up to grade 3</i></p> <p>Specify upper finish: <i>Any Vitro powder coat</i></p> <p>Specify lower finish: <i>Satin black standard, or Vitro powder coat</i></p> <p>Specify: <i>Bolt down or core drill</i></p>	<p><b>Includes 2 seat unit with 24x24 table top</b></p> <p>Specify upholstery: <i>Up to grade 3</i></p> <p>Specify upper finish: <i>Any Vitro powder coat</i></p> <p>Specify lower finish: <i>Satin black standard, or Vitro powder coat</i></p> <p>Specify: <i>Core drill only</i></p>	<p><b>Includes 4 seat unit with 24x48 table top</b></p> <p>Specify upholstery: <i>Up to grade 3</i></p> <p>Specify upper finish: <i>Any Vitro powder coat</i></p> <p>Specify lower finish: <i>Satin black standard, or Vitro powder coat</i></p> <p>Specify: <i>Core drill only</i></p>



With Table Top <i>Specify: BN or BGA - 125</i>	With Table Top <i>Specify: BN or BGA - 125</i>	With Table Top <i>Specify: BN or BGA - 125</i>
5303.61	1227.03	2454.07
Without Table 4638.18	Without Table 1093.93	Without Table 2187.92



With Table Top <i>Specify: BN or BGA - 125</i>	With Table Top <i>Specify: BN or BGA - 125</i>	With Table Top <i>Specify: BN or BGA - 125</i>
5303.61	1227.03	2454.07
Without Table 4638.18	Without Table 1093.93	Without Table 2187.92



With Table Top <i>Specify: BN or BGA - 125</i>	With Table Top <i>Specify: BN or BGA - 125</i>	With Table Top <i>Specify: BN or BGA - 125</i>
5303.61	1227.03	2454.07
Without Table 4638.18	Without Table 1093.93	Without Table 2187.92



**M2W**

2 seat / wall

**Includes 2 seat unit with 24 x 24 table top**  
 Specify upholstery:  
 Up to grade 3  
 Specify upper finish:  
 Any Vitro powder coat  
 Specify lower finish:  
 Satin black standard, or Vitro powder coat  
 Specify:  
 Bolt down or core drill

**M4W**

4 seat / wall

**Includes 4 seat unit with 24 x 48 table top**  
 Specify upholstery:  
 Up to grade 3  
 Specify upper finish:  
 Any Vitro powder coat  
 Specify lower finish:  
 Satin black standard, or Vitro powder coat  
 Specify:  
 Bolt down or core drill

**M4I**

4 seat / island

**Includes 4 seat unit with 24 x 48 table top**  
 Specify upholstery:  
 Up to grade 3  
 Specify upper finish:  
 Any Vitro powder coat  
 Specify lower finish:  
 Satin black standard, or Vitro powder coat  
 Specify:  
 Bolt down or core drill

**M6W**

6 seat / wall

**Includes 6 seat unit with 24 x 76 table top**  
 Specify upholstery:  
 Up to grade 3  
 Specify upper finish:  
 Any Vitro powder coat  
 Specify lower finish:  
 Satin black standard, or Vitro powder coat  
 Specify:  
 Bolt down or core drill

Paint Only  
**X - 51 Head**

With Table Top <i>Specify: BN or BGA - 125</i>	With Table Top <i>Specify: BN or BGA - 125</i>	With Table Top <i>Specify: BN or BGA - 125</i>	With Table Top <i>Specify: BN or BGA - 125</i>
980.54	1926.82	1890.02	2847.95
Without Table 847.45	Without Table 1660.62	Without Table 1557.31	Without Table 2316.07

**X - 52 Head**

Chrome Upcharge:  
 +78.35 per head

With Table Top <i>Specify: BN or BGA - 125</i>	With Table Top <i>Specify: BN or BGA - 125</i>	With Table Top <i>Specify: BN or BGA - 125</i>	With Table Top <i>Specify: BN or BGA - 125</i>
1226.92	2419.64	2382.87	3587.62
Without Table 1093.87	Without Table 2153.48	Without Table 2050.14	Without Table 3055.27

**X - 53 Head**

Chrome Upcharge:  
 +78.35 per head

\*Limited supply

With Table Top <i>Specify: BN or BGA - 125</i>	With Table Top <i>Specify: BN or BGA - 125</i>	With Table Top <i>Specify: BN or BGA - 125</i>	With Table Top <i>Specify: BN or BGA - 125</i>
1226.92	2419.64	2382.87	3587.62
Without Table 1093.87	Without Table 2153.48	Without Table 2050.14	Without Table 3055.27

**X - 56 Head**

Chrome Upcharge:  
 +78.35 per head

With Table Top <i>Specify: BN or BGA - 125</i>	With Table Top <i>Specify: BN or BGA - 125</i>	With Table Top <i>Specify: BN or BGA - 125</i>	With Table Top <i>Specify: BN or BGA - 125</i>
1226.92	2419.64	2382.87	3587.62
Without Table 1093.87	Without Table 2153.48	Without Table 2050.14	Without Table 3055.27

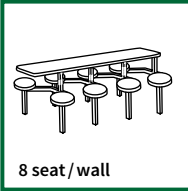
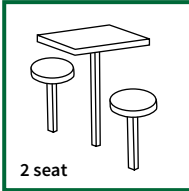
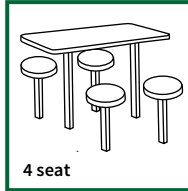
M8W	M2P	M4P
		
8 seat / wall	2 seat	4 seat
Includes 8 seat unit with 24 x 102 table top	Includes 2 seat unit with 24 x 24 table top	Includes 4 seat unit with 24 x 48 table top
Specify upholstery: <i>Up to grade 3</i>	Specify upholstery: <i>Up to grade 3</i>	Specify upholstery: <i>Up to grade 3</i>
Specify upper finish: <i>Any Vitro powder coat</i>	Specify upper finish: <i>Any Vitro powder coat</i>	Specify upper finish: <i>Any Vitro powder coat</i>
Specify lower finish: <i>Satin black standard, or Vitro powder coat</i>	Specify lower finish: <i>Satin black standard, or Vitro powder coat</i>	Specify lower finish: <i>Satin black standard, or Vitro powder coat</i>
Specify: <i>Bolt down or core drill</i>	<i>Core drill only</i>	<i>Core drill only</i>



Paint Only

**X-51 Head**

With Table Top <i>Specify: BN or BGA-125</i>	With Table Top <i>Specify: BN or BGA-125</i>	With Table Top <i>Specify: BN or BGA-125</i>
4020.42	885.41	1770.79
Without Table 3322.64	Without Table 745.66	Without Table 1491.32

Chrome Upcharge:  
+ 79.92 per head



**X-52 Head**

With Table Top <i>Specify: BN or BGA-125</i>	With Table Top <i>Specify: BN or BGA-125</i>	With Table Top <i>Specify: BN or BGA-125</i>
4944.84	1144.14	2288.24
Without Table 4246.17	Without Table 1004.39	Without Table 2008.74

Chrome Upcharge:  
+ 79.92 per head

\* Limited supply



**X-53 Head**

With Table Top <i>Specify: BN or BGA-125</i>	With Table Top <i>Specify: BN or BGA-125</i>	With Table Top <i>Specify: BN or BGA-125</i>
4944.84	1144.14	2288.24
Without Table 4246.17	Without Table 1004.39	Without Table 2008.74

Chrome Upcharge:  
+ 79.92 per head



**X-56 Head**

With Table Top <i>Specify: BN or BGA-125</i>	With Table Top <i>Specify: BN or BGA-125</i>	With Table Top <i>Specify: BN or BGA-125</i>
4944.84	1144.14	2288.24
Without Table 4246.17	Without Table 1004.39	Without Table 2008.74

**M2W**

2 seat / wall

**Includes 2 seat unit with 24 x 24 table top**  
 Specify upholstery:  
*Up to grade 3*  
 Specify upper finish:  
*Any Vitro powder coat*  
 Specify lower finish:  
*Satin black standard, or Vitro powder coat*  
 Specify:  
*Bolt down or core drill*

**M4W**

4 seat / wall

**Includes 4 seat unit with 24 x 48 table top**  
 Specify upholstery:  
*Up to grade 3*  
 Specify upper finish:  
*Any Vitro powder coat*  
 Specify lower finish:  
*Satin black standard, or Vitro powder coat*  
 Specify:  
*Bolt down or core drill*

**M4I**

4 seat / island

**Includes 4 seat unit with 24 x 48 table top**  
 Specify upholstery:  
*Up to grade 3*  
 Specify upper finish:  
*Any Vitro powder coat*  
 Specify lower finish:  
*Satin black standard, or Vitro powder coat*  
 Specify:  
*Bolt down or core drill*

**M6W**

6 seat / wall

**Includes 6 seat unit with 24 x 76 table top**  
 Specify upholstery:  
*Up to grade 3*  
 Specify upper finish:  
*Any Vitro powder coat*  
 Specify lower finish:  
*Satin black standard, or Vitro powder coat*  
 Specify:  
*Bolt down or core drill*

**46 Head**

With Table Top <i>Specify: BN or BGA-125</i>	With Table Top <i>Specify: BN or BGA-125</i>	With Table Top <i>Specify: BN or BGA-125</i>	With Table Top <i>Specify: BN or BGA-125</i>
982.16	1851.18	1774.17	2936.93
Without Table 876.99	Without Table 1719.68	Without Table 1616.38	Without Table 2404.59

**125 Head**

With Table Top <i>Specify: BN or BGA-125</i>	With Table Top <i>Specify: BN or BGA-125</i>	With Table Top <i>Specify: BN or BGA-125</i>	With Table Top <i>Specify: BN or BGA-125</i>
950.22	1787.30	1710.28	2841.12
Without Table 845.04	Without Table 1655.81	Without Table 1522.50	Without Table 2308.78

**781 Head**

With Table Top <i>Specify: BN or BGA-125</i>	With Table Top <i>Specify: BN or BGA-125</i>	With Table Top <i>Specify: BN or BGA-125</i>	With Table Top <i>Specify: BN or BGA-125</i>
950.22	1787.30	1710.28	2841.12
Without Table 845.04	Without Table 1655.81	Without Table 1522.50	Without Table 2308.78

**782 Head**

With Table Top <i>Specify: BN or BGA-125</i>	With Table Top <i>Specify: BN or BGA-125</i>	With Table Top <i>Specify: BN or BGA-125</i>	With Table Top <i>Specify: BN or BGA-125</i>
950.22	1787.30	1710.28	2841.12
Without Table 845.04	Without Table 1655.81	Without Table 1522.50	Without Table 2308.78

**M8W**

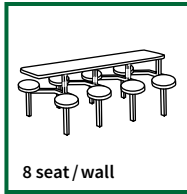

8 seat / wall

**Includes 8 seat unit with 24 x 102 table top**

Specify upholstery:  
*Up to grade 3*

Specify upper finish:  
*Any Vitro powder coat*

Specify lower finish:  
*Satin black standard, or Vitro powder coat*

Specify:  
*Bolt down or core drill*

**M2P**

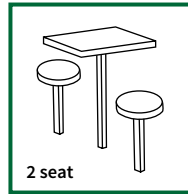

2 seat

**Includes 2 seat unit with 24 x 24 table top**

Specify upholstery:  
*Up to grade 3*

Specify upper finish:  
*Any Vitro powder coat*

Specify lower finish:  
*Satin black standard, or Vitro powder coat*

Specify:  
*Core drill only*

**M4P**

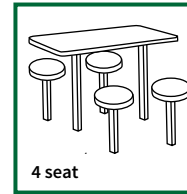

4 seat

**Includes 4 seat unit with 24 x 48 table top**

Specify upholstery:  
*Up to grade 3*

Specify upper finish:  
*Any Vitro powder coat*

Specify lower finish:  
*Satin black standard, or Vitro powder coat*

Specify:  
*Core drill only*



**46 Head**

**With Table Top**

*Specify: BN or BGA-125*

3886.47

Without Table

3221.03

**With Table Top**

*Specify: BN or BGA-125*

872.74

Without Table

739.66

**With Table Top**

*Specify: BN or BGA-125*

1746.63

Without Table

1479.36



**125 Head**

**With Table Top**

*Specify: BN or BGA-125*

3758.71

Without Table

3093.27

**With Table Top**

*Specify: BN or BGA-125*

840.79

Without Table

707.72

**With Table Top**

*Specify: BN or BGA-125*

1682.75

Without Table

1415.49



**781 Head**

**With Table Top**

*Specify: BN or BGA-125*

3886.47

Without Table

3221.03

**With Table Top**

*Specify: BN or BGA-125*

872.74

Without Table

739.66

**With Table Top**

*Specify: BN or BGA-125*

1746.63

Without Table

1479.36



**782 Head**

**With Table Top**

*Specify: BN or BGA-125*

3886.47

Without Table

3221.03

**With Table Top**

*Specify: BN or BGA-125*

872.74

Without Table

739.66

**With Table Top**

*Specify: BN or BGA-125*

1746.63

Without Table

1479.36



**M2W**

2 seat / wall

**Includes 2 seat unit with 24 x 24 table top**  
 Specify upholstery:  
*Up to grade 3*  
 Specify upper finish:  
*Any Vitro powder coat*  
 Specify lower finish:  
*Satin black standard, or Vitro powder coat*  
 Specify:  
*Bolt down or core drill*

**M4W**

4 seat / wall

**Includes 4 seat unit with 24 x 48 table top**  
 Specify upholstery:  
*Up to grade 3*  
 Specify upper finish:  
*Any Vitro powder coat*  
 Specify lower finish:  
*Satin black standard, or Vitro powder coat*  
 Specify:  
*Bolt down or core drill*

**M4I**

4 seat / island

**Includes 4 seat unit with 24 x 48 table top**  
 Specify upholstery:  
*Up to grade 3*  
 Specify upper finish:  
*Any Vitro powder coat*  
 Specify lower finish:  
*Satin black standard, or Vitro powder coat*  
 Specify:  
*Bolt down or core drill*

**M6W**

6 seat / wall

**Includes 6 seat unit with 24 x 76 table top**  
 Specify upholstery:  
*Up to grade 3*  
 Specify upper finish:  
*Any Vitro powder coat*  
 Specify lower finish:  
*Satin black standard, or Vitro powder coat*  
 Specify:  
*Bolt down or core drill*

**125 RB Head**

With Table Top <i>Specify: BN or BGA-125</i>	With Table Top <i>Specify: BN or BGA-125</i>	With Table Top <i>Specify: BN or BGA-125</i>	With Table Top <i>Specify: BN or BGA-125</i>
1147.40	2181.65	2104.15	3432.61
Without Table 1042.20	Without Table 2050.14	Without Table 1946.36	Without Table 2900.28

**782 RB Head**

With Table Top <i>Specify: BN or BGA-125</i>	With Table Top <i>Specify: BN or BGA-125</i>	With Table Top <i>Specify: BN or BGA-125</i>	With Table Top <i>Specify: BN or BGA-125</i>
1203.82	2294.46	2216.96	3601.83
Without Table 1098.61	Without Table 2162.95	Without Table 2059.17	Without Table 3069.50

**921 Head**  
*Add 37.83 for "V"*

With Table Top <i>Specify: BN or BGA-125</i>	With Table Top <i>Specify: BN or BGA-125</i>	With Table Top <i>Specify: BN or BGA-125</i>	With Table Top <i>Specify: BN or BGA-125</i>
1171.89	2230.66	2153.15	3506.11
Without Table 1066.70	Without Table 2099.14	Without Table 1995.35	Without Table 2973.77

**939 CBWF Head**

With Table Top <i>Specify: BN or BGA-125</i>	With Table Top <i>Specify: BN or BGA-125</i>	With Table Top <i>Specify: BN or BGA-125</i>	With Table Top <i>Specify: BN or BGA-125</i>
1198.17	2256.94	2179.42	3532.39
Without Table 1092.97	Without Table 2125.41	Without Table 2021.09	Without Table 3000.06

**M8W**

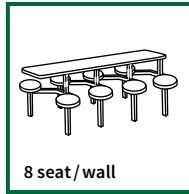

8 seat / wall

**Includes 8 seat unit with 24 x 102 table top**

Specify upholstery:  
*Up to grade 3*

Specify upper finish:  
*Any Vitro powder coat*

Specify lower finish:  
*Satin black standard, or Vitro powder coat*

Specify:  
*Bolt down or core drill*

**M2P**

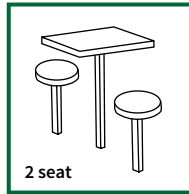

2 seat

**Includes 2 seat unit with 24 x 24 table top**

Specify upholstery:  
*Up to grade 3*

Specify upper finish:  
*Any Vitro powder coat*

Specify lower finish:  
*Satin black standard, or Vitro powder coat*

*Core drill only*

**M4P**

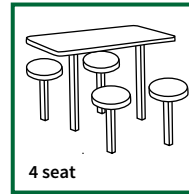

4 seat

**Includes 4 seat unit with 24 x 48 table top**

Specify upholstery:  
*Up to grade 3*

Specify upper finish:  
*Any Vitro powder coat*

Specify lower finish:  
*Satin black standard, or Vitro powder coat*

*Core drill only*



**125 RB Head**

**With Table Top**

*Specify: BN or BGA-125*

4547.35

Without Table

3881.95

**With Table Top**

*Specify: BN or BGA-125*

1047.09

Without Table

914.05

**With Table Top**

*Specify: BN or BGA-125*

2075.99

Without Table

1809.79



**782 RB Head**

**With Table Top**

*Specify: BN or BGA-125*

4772.97

Without Table

4107.55

**With Table Top**

*Specify: BN or BGA-125*

1103.51

Without Table

970.43

**With Table Top**

*Specify: BN or BGA-125*

2188.78

Without Table

1922.59



**921 Head**

*Add 38.59 for "V"*

**With Table Top**

*Specify: BN or BGA-125*

4645.49

Without Table

3979.93

**With Table Top**

*Specify: BN or BGA-125*

1071.61

Without Table

938.52

**With Table Top**

*Specify: BN or BGA-125*

2124.97

Without Table

1858.78



**939 CBWF Head**

**With Table Top**

*Specify: BN or BGA-125*

4671.64

Without Table

4006.21

**With Table Top**

*Specify: BN or BGA-125*

1144.90

Without Table

964.82

**With Table Top**

*Specify: BN or BGA-125*

2151.23

Without Table

1885.06

# Stool Heads (HD)

\* Wood Seat Add 98.81. Pricing Up To Grade 3

INN - 2120 (HD)



418.74

INN - 2220 (HD)



367.96

INN - 2320 (HD)



401.55

INN - 2420 (HD)



367.96

INN - 2520 (HD)



367.96

INN - 2620 (HD)



379.70

\*Shown with optional  
wood seat

LSC - 250 (HD)



292.52

LSC - 350 (HD)



293.75

LSC - 450 (HD)



301.89

LSC - 475 (HD)



301.89

LSC - 501 (HD)



348.71

\*Shown with optional  
wood seat

LSC - 550 (HD)



348.71

LSC - 575 (HD)



348.71

LSC - 600 (HD)



348.71

LSC - 650 (HD)



312.01

LSC - 750 (HD)



302.65

\*Shown with optional  
wood seat

OX - 10 (HD)



412.78

OX - 20 (HD)



412.78

OX - 30 (HD)



412.78

OX - 40 (HD)



341.90

*\*Available in paint finishes only*

**PREMIUM PAINT: 14.65**  
**POWDER CHROME: 29.28**



348.73

Paint Only



348.73

Paint Only



283.04

Paint Only



242.94

Paint Only



278.26

Paint Only



199.79

Add 79.98 for Chrome



220.45

Add 79.98 for Chrome



209.04

Add 79.98 for Chrome



143.02



145.11



282.46

Add 38.59 for "V"



107.36

Paint Only



133.88



270.43

Add 38.59 for "V"



143.02



145.16



282.46

Add 38.59 for "V"



321.84



225.57

Add 38.59 for "V"



302.53

**PREMIUM PAINT: 14.65**  
**POWDER CHROME: 29.28**

# Cantilevered Counter Stools

\* Available with all head styles. Call for pricing.

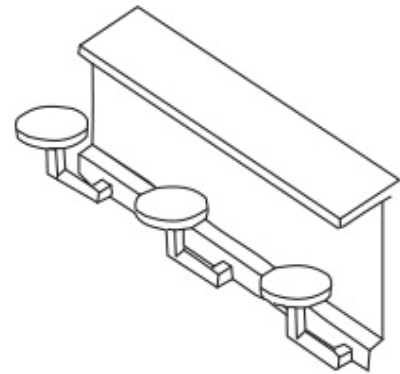

Up to Grade 3

Up to Grade 5

Head Style	Painted Cantilever with Painted Head	Chrome Cantilever with Chrome Head
FB - PS (HD)	765.78	N/A
DS - PS (HD)	765.78	N/A
HP - PS (HD)	765.78	N/A
X - 23 (HD)	618.93	790.46
X - 51 (HD)	693.63	N/A
X - 52 (HD)	693.63	885.82
X - 53 (HD)	693.63	885.82
X - 55 (HD)	693.63	885.82
46 (HD)	503.87	647.81
125 R (HD)	503.87	647.81
125 RB (HD)	678.61	822.54
242 (HD)	684.46	828.40
531 (HD)	678.61	822.54
781 (HD)	503.85	647.81
782 (HD)	503.85	647.81
782 RB (HD)	678.61	822.54
921 (HD)	678.61	822.54
921"V"(HD)	705.16	849.10
939 CB (HD)	684.46	828.40

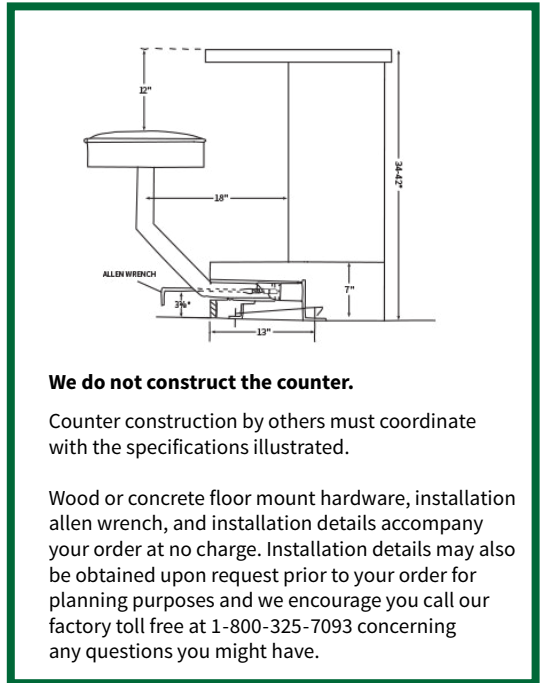

## Cantilevered Counter Stools

Available with single shoes only  
(the shoe is the lower portion).

Single

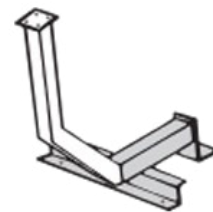

**PREMIUM PAINT: 14.65**  
**POWDER CHROME: 29.28**

# Modular Seating Plan

\* Not Shown To Scale

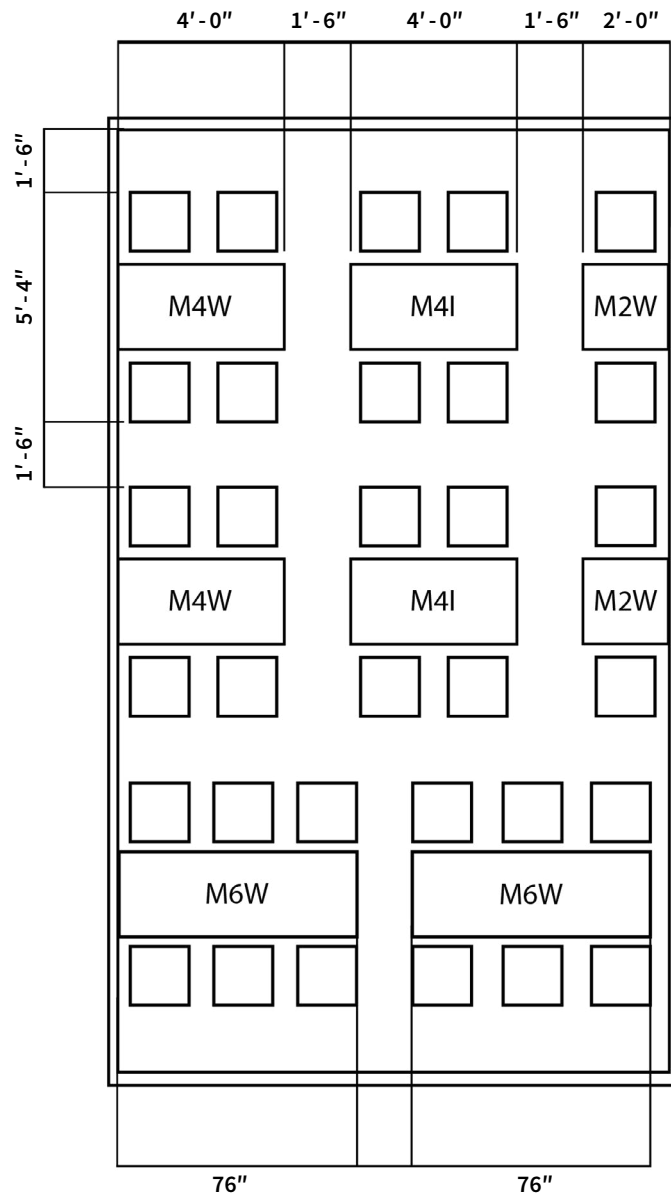

## Note:

It is the responsibility of the owner or contractor to verify all building code requirements for total occupancy, Exiting and accessibility, Federal, State, City, and Municipal.

## Note:

It is the owner's responsibility to verify all dimensions prior to order and fabrication.



# BOOTHS

## Call Factory for Custom Sizes & Shapes



### Single Booth

Seats 2 people side by side, generally 24" deep x 44" long. 48" length is also popular.

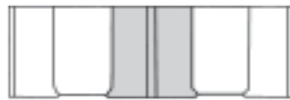

### Double Booth

Seats 4 people (2 people side by side, as well as back to back), generally 45" deep x 44" long. 48" length is also popular.



### Wallbench

Constructed in virtually any length with sections normally restricted to 8ft. Attention should be given to location of the seams for aesthetic reasons, as well as comfort to the user.

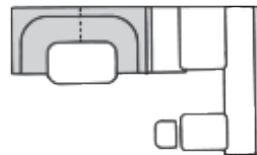

### 1/2 Circle Booth

Generally constructed in (2) 1/4 circle pieces with standard dimensions of 44" x 84" x 44". The outside back is always unfinished unless otherwise specified for aesthetic reasons, such as exposure due to windows, or perhaps no walls to cover the back.

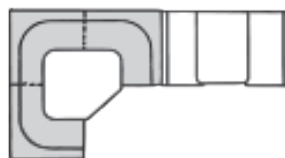

### 3/4 Circle Booth

Generally constructed in (3) 1/4 circle pieces with standard dimensions of 44" x 84" x 84" x 44". Again, the outside back remains unfinished unless otherwise specified.

# Booth Options

Please Indicate the Booth number followed by the option number,  
for example : **OZ - 2, SR - 3, LH - 4, etc.**

<b>(Option Code - 2)</b>	Laminate top & end panels.....	Add 132.93
<b>(Option Code - 3)</b>	Wood top cap & end panels.....	Add 159.47
<b>(Option Code - 4)</b>	42" height utilizing horizontal headrest....	Add 25%
<b>(Option Code - 5)</b>	42" height.....	Add 15%
<b>(Option Code - 6)</b>	Wood top cap & full end panels.....	Add 265.87
<b>(Option Code - 7)</b>	48" Height.....	Add 35%
<b>(Option Code - 8)</b>	Laminate top cap.....	Add 60.31
<b>(Option Code - 9)</b>	60" height.....	Add 15% & 35%
<b>(Option Code- 10)</b>	Bar Height - 30" Seat Height.....	Add 25%
<b>(Option Code - LSB)</b>	Laminate sub base.....	Add 132.93 single/175.51 double
<b>(Option Code - LCS)</b>	Laminate crumb strip.....	Add 63.81 single/127.57 double
<b>(Option Code - UCS)</b>	Upholstered crumb strip.....	Add 53.17 single/106.31 double
<b>(Option Code - WTC)</b>	Wood top cap.....	Add 79.75
<b>(Option Code - WSB)</b>	Wood sub base.....	Add 265.87 single/347.83 double
<b>(Option Code - LOB)</b>	Laminate outside back.....	Add 347.83
<b>(Option Code - WOB)</b>	Wood outside back .....	Add 201.09 per ft
<b>(Option Code - LB)</b>	Laminate base.....	Add 159.47 single/239.26 double
	* Special Stain.....	Call Factory For Pricing

Wood & Metal legs available - call for pricing

30" length or less.....	Deduct 10%
48" length.....	Add 5%
60" length.....	Add 30%

**Note:** Add 425.27 for each 90° corner when using wallbench pricing

**Note:** Add 1595.22 for each mitered corner when using wallbench pricing

Radius booths available - call for pricing

## See Page 123 For All Available Options



### The Gateway Series in standard form (Model GY - 1)

represents a fully upholstered booth featuring a simple economical, smooth inside back and 36" overall height with NO top cap or sub base.

	Grade 1	Grade 2	Grade 3	Grade 4	Grade 5	Weight	Dimensions
Single	792.83	820.57	849.31	879.03	909.79	110 lbs	24"D x 44"W
Double	1189.26	1230.88	1273.96	1318.52	1364.68	150 lbs	45"D x 44"W
Wallbench per ft.	306.08	316.79	327.86	339.37	351.21	35 lbs	N/A
¼ Circle	2873.84	2959.53	3048.25	3140.05	3235.09	210 lbs	44" x 44"
½ Circle	5441.65	5602.33	5768.64	5940.76	6118.92	410 lbs	44" x 84" x 44"
¾ Circle	8009.43	8245.10	8489.04	8741.49	9002.76	575 lbs	44" x 84" x 84" x 44"
OSB per ft.	53.03	54.89	56.82	58.81	60.86	N/A	N/A



### The Ozark Series in standard form (Model OZ - 1)

represents a fully upholstered booth featuring a smooth inside back and 36" overall height.

\* "V" option add 255.44 (Single), 510.88 (Double)

	Grade 1	Grade 2	Grade 3	Grade 4	Grade 5	Weight	Dimensions
Single	901.20	932.74	965.37	999.17	1034.11	110 lbs	24"D x 44"W
Double	1351.79	1399.11	1448.07	1498.73	1551.20	150 lbs	45"D x 44"W
Wallbench per ft.	307.55	318.32	329.46	341.01	352.92	35 lbs	N/A
¼ Circle	2885.76	2971.86	3060.99	3153.25	3248.72	210 lbs	44" x 44"
½ Circle	5463.96	5625.43	5792.55	5965.50	6144.52	410 lbs	44" x 84" x 44"
¾ Circle	8042.14	8278.96	8524.09	8777.76	9040.34	575 lbs	44" x 84" x 84" x 44"
OSB per ft.	53.03	54.89	56.82	58.81	60.86	N/A	N/A

## Midway Booths Are Only Available In Grade 1 Modena Vinyl



Midway Smooth

The Midway Series in standard form (Model MD - 1000)

represents a fully upholstered booth featuring 36" height.

No top cap. **Available in Grade 1 Modena Vinyl only.**

	Price	Weight	Dimensions
Single	819.71	110 lbs	24"D x 44"W
Double	1240.05	150 lbs	45"D x 44"W



Midway 3 panel

The Midway Series in standard form (Model MD - 3000)

with the 3 panel option. No top cap. **Available in Grade 1**

**Modena Vinyl only.**

	Price	Weight	Dimensions
Single	869.95	110 lbs	24"D x 44"W
Double	1343.86	150 lbs	45"D x 44"W



Midway 4 panel

The Midway Series in standard form (Model MD - 4000)

with the 4 panel option. No top cap. **Available in Grade 1**

**Modena Vinyl only.**

	Price	Weight	Dimensions
Single	966.82	110 lbs	24"D x 44"W
Double	1450.24	150 lbs	45"D x 44"W

## See Page 123 For All Available Options

**The Sierra Series** in standard form (**Model SR - 1**)

represents a fully upholstered booth featuring 3 smooth panels separated by welt cord on the inside back and 36" overall height.

*\* Shown with optional two color upholstery*

	Grade 1	Grade 2	Grade 3	Grade 4	Grade 5	Weight	Dimensions
Single	944.67	977.72	1011.93	1047.36	1084.01	110 lbs	24"D x 44"W
Double	1416.92	1466.56	1517.92	1571.03	1626.02	150 lbs	45"D x 44"W
Wallbench per ft.	318.26	329.41	340.93	352.84	365.20	35 lbs	N/A
¼ Circle	2971.33	3060.43	3152.65	3248.12	3346.92	210 lbs	44" x 44"
½ Circle	5619.57	5791.48	5964.40	6143.38	6328.63	410 lbs	44" x 84" x 44"
¾ Circle	8277.46	8522.51	8776.15	9038.66	9310.33	575 lbs	44" x 84" x 84" x 44"
OSB per ft.	53.03	54.89	56.82	58.81	60.86	N/A	N/A

**The Horizon Series** in standard form (**Model HZ - 1**)

represents a solid wood trim top cap end panel and sub-base end panel with radiused edges, laminated crumb tray & sub-base are all standard, 35½" O.A. height.

*\* Straight wallbenches only (Max 72" L)*

	Grade 1	Grade 2	Grade 3	Grade 4	Grade 5	Weight	Dimensions
Single	1512.23	1565.14	1619.91	1676.61	1735.29	185 lbs	24"D x 44"W
Double	2268.28	2347.69	2429.84	2514.90	2602.92	240 lbs	46"D x 44"W
Wallbench per ft.	476.92	493.60	510.88	528.75	547.26	46 lbs	Max 72" L

*\*Finished 2 sides add 125.16 to above single & Double Add 187.74*

*\*Standard wood trim is one side finished only*



Lockhaven

### The Lockhaven Series in standard form (Model LH - 1)

represents a fully upholstered booth featuring vertical channel tufting on 7" centers and 36" overall height.

*\* Shown with optional wood top cap and three color upholstery*

*\* Shown with optional accent piping*

	Grade 1	Grade 2	Grade 3	Grade 4	Grade 5	Weight	Dimensions
Single	1141.55	1181.51	1222.87	1265.66	1309.98	110 lbs	24"D x 44"W
Double	1712.34	1772.28	1834.29	1898.49	1964.95	150 lbs	45"D x 44"W
Wallbench per ft.	345.27	357.36	369.85	382.81	396.21	35 lbs	N/A
¼ Circle	3187.47	3284.15	3384.21	3487.78	3594.97	210 lbs	44" x 44"
½ Circle	6029.70	6210.97	6398.58	6592.74	6793.71	410 lbs	44" x 84" x 44"
¾ Circle	8871.90	9137.74	9412.92	9697.71	9992.47	575 lbs	44" x 84" x 84" x 44"
OSB per ft.	53.03	54.89	56.82	58.81	60.86	N/A	N/A



Lockhaven Optional

### The Lockhaven Series (Optional Model LH - 2 - LSB)

represents a fully upholstered booth featuring vertical channel tufting on 7" centers and 36" overall height, with laminated top cap, end panels and sub base.

	Grade 1	Grade 2	Grade 3	Grade 4	Grade 5	Weight	Dimensions
Single	1407.40	1447.37	1488.72	1531.51	1575.82	110 lbs	24"D x 44"W
Double	1978.20	2038.11	2100.15	2164.37	2230.79	150 lbs	45"D x 44"W
Wallbench per ft.	421.03	433.12	445.63	458.56	471.96	35 lbs	N/A
¼ Circle	3793.50	3890.01	3990.24	4093.74	4200.98	210 lbs	44" x 44"
½ Circle	7165.98	7347.25	7534.86	7729.04	7930.01	410 lbs	44" x 84" x 44"
¾ Circle	10538.47	10804.33	11079.47	11364.27	11659.03	575 lbs	44" x 84" x 84" x 44"
OSB per ft.	53.03	54.89	56.82	58.81	60.86	N/A	N/A

## See Page 123 For All Available Options



Serenade

## The Serenade Series in standard form (Model SD - 1)

represents a fully upholstered booth featuring diamond tufting and 36" overall height.

	Grade 1	Grade 2	Grade 3	Grade 4	Grade 5	Weight	Dimensions
Single	1206.84	1249.22	1292.82	1338.06	1384.89	110 lbs	24"D x 44"W
Double	1810.29	1873.65	1939.23	2007.09	2077.36	150 lbs	45"D x 44"W
Wallbench per ft.	389.74	403.36	417.50	432.11	447.24	35 lbs	N/A
¼ Circle	3543.25	3652.38	3765.31	3882.21	4003.21	210 lbs	44" x 44"
½ Circle	6696.73	6901.36	7113.15	7332.32	7559.18	410 lbs	44" x 84" x 44"
¾ Circle	9850.26	10150.37	10460.95	10782.42	11115.15	575 lbs	44" x 84" x 84" x 44"
OSB per ft.	53.03	54.89	56.82	58.81	60.86	N/A	N/A



Serenade Optional

## The Serenade Series (Optional Model SD - 2)

represents a fully upholstered booth featuring diamond tufting and 36" overall height, with laminated top cap & end panels.

	Grade 1	Grade 2	Grade 3	Grade 4	Grade 5	Weight	Dimensions
Single	1339.79	1382.02	1425.75	1471.00	1517.83	110 lbs	24"D x 44"W
Double	1943.23	2006.57	2072.16	2140.02	2210.26	150 lbs	45"D x 44"W
Wallbench per ft.	427.61	441.27	455.39	469.98	485.11	35 lbs	N/A
¼ Circle	3846.25	3955.39	4068.34	4185.24	4306.21	210 lbs	44" x 44"
½ Circle	7264.87	7469.51	7681.28	7900.47	8127.33	410 lbs	44" x 84" x 44"
¾ Circle	10683.52	10983.63	11294.24	11615.71	11948.44	575 lbs	44" x 84" x 84" x 44"
OSB per ft.	53.03	54.89	56.82	58.81	60.86	N/A	N/A



Gravois

### The Gravois Series in standard form (Model GV - 1)

represents a fully upholstered booth featuring a horizontal head roll atop a smooth, lower inside back and 36" overall height.

*\* Shown with optional three color upholstery*

	Grade 1	Grade 2	Grade 3	Grade 4	Grade 5	Weight	Dimensions
Single	1160.47	1201.06	1243.10	1286.61	1331.65	110 lbs	24"D x 44"W
Double	1740.67	1801.61	1864.66	1929.92	1997.48	150 lbs	45"D x 44"W
Wallbench per ft.	340.39	352.31	364.64	377.42	390.62	35 lbs	N/A
¼ Circle	3148.55	3243.87	3342.51	3444.62	3550.32	210 lbs	44" x 44"
½ Circle	5956.71	6135.41	6320.39	6511.83	6709.96	410 lbs	44" x 84" x 44"
¾ Circle	8764.86	9026.99	9298.27	9579.04	9869.80	575 lbs	44" x 84" x 84" x 44"
OSB per ft.	53.03	54.89	56.82	58.81	60.86	N/A	N/A



Gravois Optional

### The Gravois Series (Optional Model GV - 3)

represents a fully upholstered booth featuring a horizontal head roll atop a smooth, lower inside back and 36" overall height, with wood top cap & end panels.

	Grade 1	Grade 2	Grade 3	Grade 4	Grade 5	Weight	Dimensions
Single	1319.95	1360.58	1402.61	1446.12	1491.15	110 lbs	24"D x 44"W
Double	1900.19	1961.13	2024.16	2089.45	2156.99	150 lbs	45"D x 44"W
Wallbench per ft.	385.95	397.89	410.20	422.97	436.19	35 lbs	N/A
¼ Circle	3513.02	3608.30	3706.97	3809.05	3914.75	210 lbs	44" x 44"
½ Circle	6640.06	6818.78	7003.74	7195.17	7393.31	410 lbs	44" x 84" x 44"
¾ Circle	9767.10	10029.21	10300.48	10586.12	10871.88	575 lbs	44" x 84" x 84" x 44"
OSB per ft.	53.03	54.89	56.82	58.81	60.86	N/A	N/A

## See Page 123 For All Available Options



Fenton

**The Fenton Series** in standard form (**Model FN - 1**)

represents a fully upholstered booth featuring 3 horizontal channels and 36" overall height.

*\* Shown with optional two color upholstery*

	Grade 1	Grade 2	Grade 3	Grade 4	Grade 5	Weight	Dimensions
Single	1349.59	1396.84	1445.71	1496.31	1548.69	110 lbs	24"D x 44"W
Double	2024.37	2095.25	2168.58	2244.48	2323.05	150 lbs	45"D x 44"W
Wallbench per ft.	396.31	410.20	424.57	439.43	454.81	35 lbs	N/A
¼ Circle	3595.98	3706.97	3821.83	3940.69	4063.73	210 lbs	44" x 44"
½ Circle	6795.67	7003.74	7219.09	7441.99	7672.68	410 lbs	44" x 84" x 44"
¾ Circle	9995.33	10300.48	10616.36	10943.28	11281.63	575 lbs	44" x 84" x 84" x 44"
OSB per ft.	53.03	54.89	56.82	58.81	60.86	N/A	N/A



Millennium Booth

**The Millennium Series (MIL - 1)**

represents a fully upholstered contemporary booth design featuring a smooth inside back, high profile seating / small profile base, and 36" height.

	Grade 1	Grade 2	Grade 3	Grade 4	Grade 5	Weight	Dimensions
Single	1116.32	1155.40	1195.82	1237.67	1281.00	110 lbs	24"D x 44"W
Double	1674.44	1733.06	1793.74	1856.47	1927.94	150 lbs	45"D x 44"W
Wallbench per ft.	369.40	382.32	395.72	409.56	423.88	35 lbs	N/A
¼ Circle	3380.48	3483.91	3590.96	3701.76	3816.43	210 lbs	44" x 44"
½ Circle	6391.57	6585.50	6786.21	6993.97	7208.96	410 lbs	44" x 84" x 44"
¾ Circle	9402.65	9687.08	9981.45	10286.17	10601.52	575 lbs	44" x 84" x 84" x 44"
OSB per ft.	53.03	54.89	56.82	58.81	60.86	N/A	N/A

## See Page 123 For All Available Options



Streamliner

**The Streamliner Series** in standard form (**Model ST - 4300**) represents a fully upholstered booth featuring double twin outer channel back with a classic high base design. This attractive booth is offered in two colors upholstery at no extra charge. Standard 36" height.

	Grade 1	Grade 2	Grade 3	Grade 4	Grade 5	Weight	Dimensions
Single	1172.07	1213.11	1255.57	1299.50	1344.97	110 lbs	24"D x 44"W
Double	1758.13	1819.66	1883.33	1949.24	2017.48	150 lbs	45"D x 44"W
Wallbench per ft.	387.87	401.43	415.46	430.03	445.07	35 lbs	N/A
¼ Circle	3528.13	3636.73	3749.14	3865.47	3985.86	210 lbs	44" x 44"
½ Circle	6668.40	6872.02	7082.78	7300.89	7526.66	410 lbs	44" x 84" x 44"
¾ Circle	9808.66	10107.32	10416.41	10736.34	11067.44	575 lbs	44" x 84" x 84" x 44"
OSB per ft.	53.03	54.89	56.82	58.81	60.86	N/A	N/A



Odyssey

**The Odyssey Series** in standard form (**Model OD - 6000**) represents a unique, thin line style from the past. Frame is available in painted finishes only.

*\* Shown with optional accent piping & buttons*

*\* Button upcharge add 80.60 (Single), 161.20 (Double)*



Single

	Grade 1	Grade 2	Grade 3	Grade 4	Grade 5	Weight	Dimensions
Single	1121.31	1160.56	1201.21	1243.25	1286.78	85 lbs	24"D x 44"W
Double	1681.99	1740.87	1801.80	1864.85	1930.13	110 lbs	45"D x 44"W
Wallbench per ft.	327.27	338.71	350.58	362.82	375.54	25 lbs	N/A
OSB per ft.	53.03	54.89	56.82	58.81	60.86	N/A	N/A

*\*30" length or less deduct 10%*

*\*48" length add 5%*

*\*60" length add 30%*

See Page 123 For All Available Options



Norwood

### The Norwood Series (Model NW-5-CT-UCS)

represents a fully upholstered booth featuring a custom gallery (CT), and a 42" overall height with wood top cap & end panels.

*\* Standard wood trim is finished on one side only*

*\* Finished 2 sides add 125.16 to single & 187.74 for double*

	Grade 1	Grade 2	Grade 3	Grade 4	Grade 5	Weight	Dimensions
Single	2146.59	2221.72	2299.50	2379.99	2463.26	205 lbs	24"D x 44"W
Double	3219.90	3332.59	3449.25	3569.95	3694.90	260 lbs	45"D x 44"W



Norwood

### The Norwood Series (Optional Model NW-5-UCS-WSB)

represents a fully upholstered smooth back booth featuring a 42" max overall height with wood top cap, sub-base, and end panels.

*\* Standard wood trim is finished on one side only*

*\* Finished 2 sides add 125.16 to single & 187.74 for double*

*\* Max height is 42"*

	Grade 1	Grade 2	Grade 3	Grade 4	Grade 5	Weight	Dimensions
Single	2065.26	2137.52	2212.34	2289.79	2369.94	205 lbs	24"D x 44"W
Double	3097.88	3206.31	3318.51	3434.67	3554.88	260 lbs	45"D x 44"W



Bel - Air

### The Bel - Air Series in standard form (Model BA - 4300)

represents a fully upholstered booth featuring a smooth inside back with a classic high base design. Standard 36" height.

	Grade 1	Grade 2	Grade 3	Grade 4	Grade 5	Weight	Dimensions
Single	876.65	907.34	939.11	971.98	1006.00	110 lbs	24"D x 44"W
Double	1315.00	1361.01	1408.66	1457.97	1508.99	150 lbs	45"D x 44"W
Wallbench per ft.	329.81	341.35	353.30	365.65	378.46	35 lbs	N/A
¼ Circle	3063.63	3155.96	3251.58	3350.48	3452.84	210 lbs	44" x 44"
½ Circle	5797.47	5970.63	6149.83	6335.31	6527.26	410 lbs	44" x 84" x 44"
¾ Circle	8531.34	8785.27	9048.10	9320.11	9601.67	575 lbs	44" x 84" x 84" x 44"
OSB per ft.	53.03	54.89	56.82	58.81	60.86	N/A	N/A



Vintage

### The Vintage Series (Model V - 4300)

represents a fully upholstered booth of classic design. "V" back with choice of the high enclosed base (standard) or the optional high pedestal design. No charge for contrasting "V" and welt in same grade. Standard 36" height.

	Grade 1	Grade 2	Grade 3	Grade 4	Grade 5	Weight	Dimensions
Single	1116.32	1155.40	1195.82	1237.67	1281.00	110 lbs	24"D x 44"W
Double	1674.44	1733.06	1793.74	1856.47	1927.94	150 lbs	45"D x 44"W
Wallbench per ft.	369.40	382.32	395.72	409.56	423.88	35 lbs	N/A
¼ Circle	3380.48	3483.91	3590.96	3701.76	3816.43	210 lbs	44" x 44"
½ Circle	6391.57	6585.50	6786.21	6993.97	7208.96	410 lbs	44" x 84" x 44"
¾ Circle	9402.65	9687.08	9981.45	10286.17	10601.52	575 lbs	44" x 84" x 84" x 44"
OSB per ft.	53.03	54.89	56.82	58.81	60.86	N/A	N/A

## See Page 123 For All Available Options



Hollywood

**The Hollywood Series** in standard form (**Model HW - 4300**)

represents a fully upholstered booth featuring vertical channel tufting on 7" centers. High enclosed base is standard or choose the optional high pedestal design. Standard 36" height.

	Grade 1	Grade 2	Grade 3	Grade 4	Grade 5	Weight	Dimensions
Single	1172.07	1213.11	1255.57	1299.50	1344.97	110 lbs	24"D x 44"W
Double	1758.13	1819.66	1883.33	1949.24	2017.48	150 lbs	45"D x 44"W
Wallbench per ft.	387.87	401.43	415.46	430.03	445.07	35 lbs	N/A
¼ Circle	3528.13	3636.73	3749.14	3865.47	3985.86	210 lbs	44" x 44"
½ Circle	6668.40	6872.02	7082.78	7300.89	7526.66	410 lbs	44" x 84" x 44"
¾ Circle	9808.66	10107.32	10416.41	10736.34	11067.44	575 lbs	44" x 84" x 84" x 44"
OSB per ft.	53.03	54.89	56.82	58.81	60.86	N/A	N/A



Chevie

**The Chevie Series** in standard form (**Model CH - 1**)

represents a fully upholstered booth featuring a "V" shape head roll with 11 vertical channels at 4" centers. This attractive booth is offered in two colors of upholstery in same grade at no extra charge. Standard 36" height.

*\* Shown with optional accent piping*

	Grade 1	Grade 2	Grade 3	Grade 4	Grade 5	Weight	Dimensions
Single	1546.32	1600.45	1656.46	1714.44	1774.46	110 lbs	24"D x 44"W
Double	2319.49	2400.69	2484.69	2571.68	2661.69	150 lbs	45"D x 44"W
Wallbench per ft.	454.81	470.71	487.19	504.24	521.89	35 lbs	N/A
¼ Circle	4063.70	4191.05	4322.83	4459.27	4600.47	210 lbs	44" x 44"
½ Circle	7672.62	7911.37	8158.50	8414.28	8679.01	410 lbs	44" x 84" x 44"
¾ Circle	11281.51	11631.73	11994.16	12369.30	12757.57	575 lbs	44" x 84" x 84" x 44"
OSB per ft.	53.03	54.89	56.82	58.81	60.86	N/A	N/A

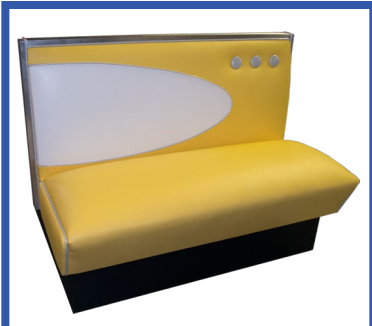
**Vette**

**Vette (Model VT - 4300)** represents a fully upholstered booth featuring a custom classic car inside back design with a classic high base design. Standard 36" height.

	Grade 1	Grade 2	Grade 3	Grade 4	Grade 5	Weight	Dimensions
<b>Single</b>	1546.32	1600.45	1656.46	1714.44	1774.46	110 lbs	24"D x 44"W
<b>Double</b>	2319.49	2400.69	2484.69	2571.68	2661.69	150 lbs	45"D x 44"W

**Malibu II**

### Malibu II (Model MB2 - 4300)

represents a fully upholstered booth of classic design featuring a roll and pleat tufted back insert and seat. Standard 36" height.

*\* Refer to Seaquest card for available tufted colors*

	Grade 1	Grade 2	Grade 3	Grade 4	Grade 5	Weight	Dimensions
<b>Single</b>	1546.32	1600.45	1656.46	1714.44	1774.46	110 lbs	24"D x 44"W
<b>Double</b>	2319.49	2400.69	2484.69	2571.68	2661.69	150 lbs	45"D x 44"W

See Page 123 For All Available Options

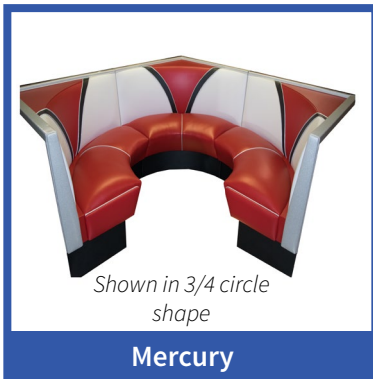

**Mercury (Model MC - 4300)** represents a fully upholstered booth featuring a double "V" design. High enclosed base is standard or choose the optional high pedestal design. Standard 36" height and includes three colors.

	Grade 1	Grade 2	Grade 3	Grade 4	Grade 5	Weight	Dimensions
Single	1546.32	1600.45	1656.46	1714.44	1774.46	110 lbs	24"D x 44"W
Double	2319.49	2400.69	2484.69	2571.68	2661.69	150 lbs	45"D x 44"W
Wallbench per ft.	454.81	470.71	487.19	504.24	521.89	35 lbs	N/A
¼ Circle	4063.70	4191.05	4322.83	4459.27	4600.47	210 lbs	44" x 44"
½ Circle	7672.62	7911.37	8158.50	8414.28	8679.01	410 lbs	44" x 84" x 44"
¾ Circle	11281.51	11631.73	11994.16	12369.30	12757.57	575 lbs	44" x 84" x 84" x 44"
OSB per ft.	53.03	54.89	56.82	58.81	60.86	N/A	N/A



### Continental (Model CT - 4300)

represents a fully upholstered booth featuring a custom "Continental" look. This attractive booth is offered in two colors of upholstery in same grade at no extra charge. Standard 36" height.

*\* Shown with optional accent piping*

	Grade 1	Grade 2	Grade 3	Grade 4	Grade 5	Weight	Dimensions
Single	1546.32	1600.45	1656.46	1714.44	1774.46	110 lbs	24"D x 44"W
Double	2319.49	2400.69	2484.69	2571.68	2661.69	150 lbs	45"D x 44"W

## See Page 123 For All Available Options



### The Elite Series in standard form (Model EL - 4300)

represents a fully upholstered booth of classic design. "Elite" back with the choice of the high enclosed base (standard) or the optional high pedestal design. No charge for contrasting "Elite-V" and welt in same grade. Standard 36" height.

*\*Shown with optional acrylic booth divider (see page 173)*

	Grade 1	Grade 2	Grade 3	Grade 4	Grade 5	Weight	Dimensions
Single	1116.32	1155.40	1195.82	1237.67	1281.00	110 lbs	24"D x 44"W
Double	1674.44	1733.06	1793.74	1856.47	1921.50	150 lbs	45"D x 44"W
Wallbench per ft.	369.40	382.32	395.72	409.56	423.88	35 lbs	n/a
¼ Circle	3380.48	3483.91	3590.96	3701.76	3816.43	210 lbs	44" x 44"
½ Circle	6391.57	6585.50	6786.21	6993.97	7208.96	410 lbs	44" x 84" x 44"
¾ Circle	9402.65	9687.08	9981.45	10286.17	10601.52	575 lbs	44" x 84" x 84" x 44"
OSB per ft.	53.03	54.89	56.82	58.81	60.86	n/a	n/a



### The Malibu Series (Model MB - 4300)

represents a fully upholstered booth of classic design featuring a roll and pleat tufted back insert. Standard 36" height.

*\* Refer to Seaquest card for available tufted colors*

	Grade 1	Grade 2	Grade 3	Grade 4	Grade 5	Weight	Dimensions
Single	1172.07	1213.11	1255.57	1299.50	1344.97	110 lbs	24"D x 44"W
Double	1758.13	1819.66	1883.33	1949.24	2017.48	150 lbs	45"D x 44"W
Wallbench per ft.	387.87	401.43	415.46	430.03	445.07	35 lbs	N/A
¼ Circle	3528.13	3636.73	3749.14	3865.47	3985.86	210 lbs	44" x 44"
½ Circle	6668.40	6872.02	7082.78	7300.89	7526.66	410 lbs	44" x 84" x 44"
¾ Circle	9808.66	10107.32	10416.41	10736.34	11067.44	575 lbs	44" x 84" x 84" x 44"
OSB per ft.	53.03	54.89	56.82	58.81	60.86	N/A	N/A

## Settee Series is sold per foot



Settee

### The Smooth Settee in standard form (Model S - ST)

represents the smooth top, backless waiting settee.

Optional contrasting welt available upon request.

- \* Only available as a bench
- \* Shown with optional accent piping
- \* Minimum length is 24"
- \* Maximum length is 96"

	Grade 1	Grade 2	Grade 3	Grade 4	Grade 5	Weight	Dimensions
Bench per ft.	250.81	259.60	268.70	278.09	287.83	24 lbs	18"H x 20"D

\*per foot



Tufted Settee

### The Tufted Settee (Model S - TT)

represents an optional version offering tufted upholstery.

- \* Only available as a bench
- \* Shown with optional contrasting welt
- \* Minimum length is 24"
- \* Maximum length is 96"

	Grade 1	Grade 2	Grade 3	Grade 4	Grade 5	Weight	Dimensions
Bench per ft.	257.71	266.75	276.10	285.75	295.77	24 lbs	18"H x 20"D

\*per foot

# Booth Options

Please Indicate the Booth number followed by the option number,  
for example : **OZ - 2, SR - 3, LH - 4, etc.**

<b>(Option Code - 2)</b>	Laminate top & end panels.....	Add 132.93
<b>(Option Code - 3)</b>	Wood top cap & end panels.....	Add 159.47
<b>(Option Code - 4)</b>	42" height utilizing horizontal headrest....	Add 25%
<b>(Option Code - 5)</b>	42" height.....	Add 15%
<b>(Option Code - 6)</b>	Wood top cap & full end panels.....	Add 265.87
<b>(Option Code - 7)</b>	48" Height.....	Add 35%
<b>(Option Code - 8)</b>	Laminate top cap.....	Add 60.31
<b>(Option Code - 9)</b>	60" height.....	Add 15% & 35%
<b>(Option Code- 10)</b>	Bar Height - 30" Seat Height.....	Add 25%
<b>(Option Code - LSB)</b>	Laminate sub base.....	Add 132.93 single/175.51 double
<b>(Option Code - LCS)</b>	Laminate crumb strip.....	Add 63.81 single/127.57 double
<b>(Option Code - UCS)</b>	Upholstered crumb strip.....	Add 53.17 single/106.31 double
<b>(Option Code - WTC)</b>	Wood top cap.....	Add 79.75
<b>(Option Code - WSB)</b>	Wood sub base.....	Add 265.87 single/347.83 double
<b>(Option Code - LOB)</b>	Laminate outside back.....	Add 347.83
<b>(Option Code - WOB)</b>	Wood outside back .....	Add 201.09 per ft
<b>(Option Code - LB)</b>	Laminate base.....	Add 159.47 single/239.26 double
	* Special Stain.....	Call Factory For Pricing

Wood & Metal legs available - call for pricing

30" length or less.....	Deduct 10%
48" length.....	Add 5%
60" length.....	Add 30%

**Note:** Add 425.27 for each 90° corner when using wallbench pricing

**Note:** Add 1595.22 for each mitered corner when using wallbench pricing

Radius booths available - call for pricing

# BOOTH SEATING

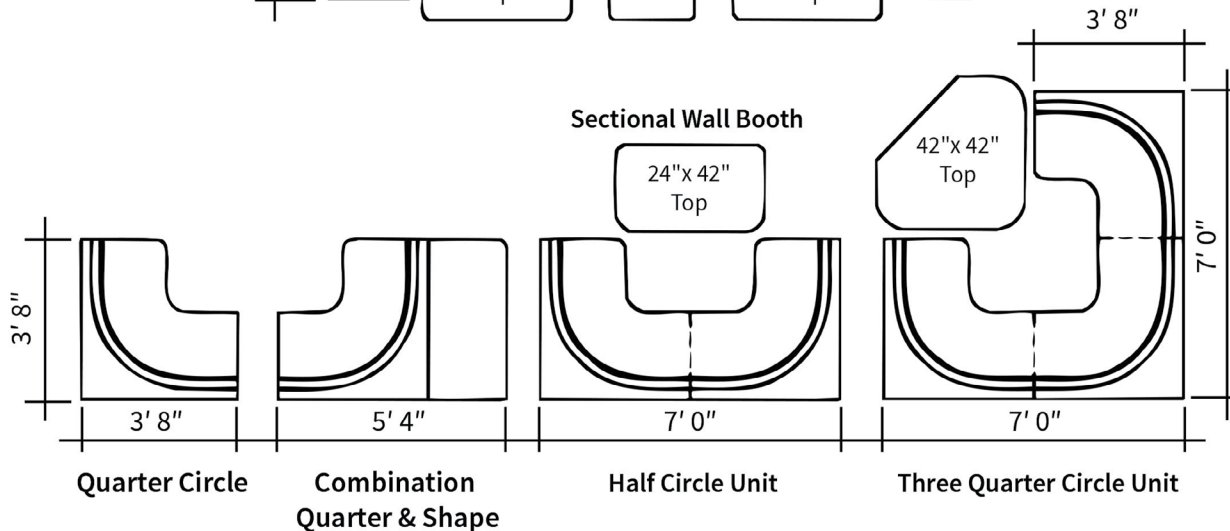
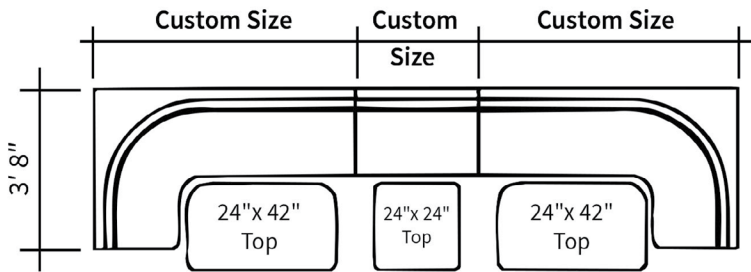
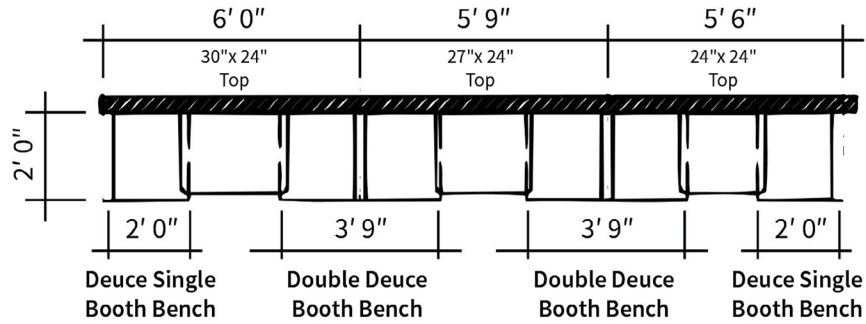
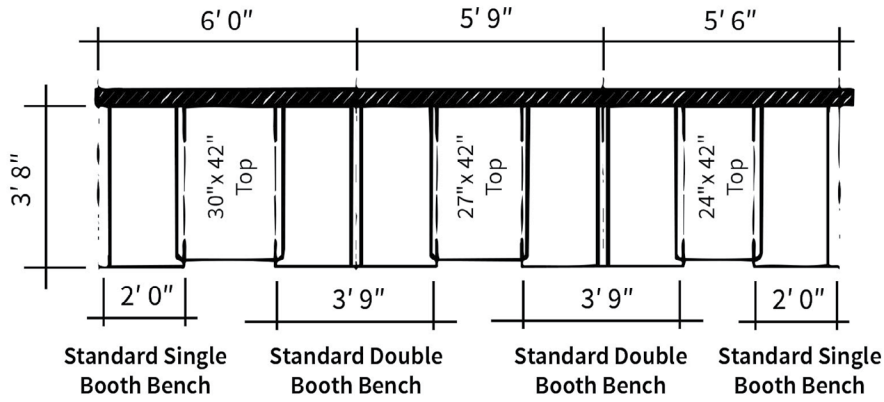

# Table Tops and Bases



*\*Ebony boomerang laminate*

## Round Table

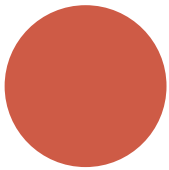

*Most common*

## Oval



*Racetrack oval*

## Wall Positioned



*Table fits flush against the wall for single and double booth seating*

## 42" x 42" CT



*Used for 3/4 circle booth*

## 1/2 CT



*Used for 1/2 circle booth*

## 1/4 CT



*Used for 1/4 circle booth*

***Custom sizes are available upon request***

*Order both Vitro tables & single column pedestal bases together and we will pre-drill tables to accommodate those bases at no charge unless stated otherwise.*

# Bumper Edge



BE - 125

\*Backing sheet add 10%

## Edge Colors

Red  
Brown  
Beige  
Almond  
Sand  
Gray  
Graphite  
Black  
White  
Natural woodgrain  
Walnut woodgrain

Call Factory for pricing on  
72" Round Tops

**BE - 125 Table Top, 1¼" x ¼" Thick Bumper Edge, laminates available in Vitro standard Wilsonart & Formica.**

	1 - 4	5 - 30	31+	Lbs.
24" x 24"	193.23	136.64	130.13	30
24" x 22"WP	193.23	136.64	130.13	30
24" x 24"CT	219.38	161.19	152.78	30
24" x 30"	226.69	167.04	159.10	35
24" x 28"WP	226.69	167.04	159.10	35
30" x 22"WP	226.69	167.04	159.10	35
24" x 42"	281.38	216.77	206.48	40
24" x 42"WP	281.38	216.77	206.48	40
24" x 42"CT	307.49	240.50	229.08	40
24" x 46"WP	295.09	229.23	218.34	45
24" x 48"	295.09	229.23	218.34	45
24" x 48"WP	295.09	229.23	218.34	45
30" x 30"	240.40	179.50	170.95	35
30" x 28"WP	240.40	179.50	170.95	40
30" x 42"	295.09	229.23	218.34	55
30" x 42"WP	295.09	229.23	218.34	55
30" x 46"WP	348.16	277.49	264.30	60
30" x 48"	348.16	277.49	264.30	60
30" x 58"WP	495.59	411.47	391.95	80
30" x 60"	495.59	411.47	391.95	80
30" x 72"	599.19	505.69	481.67	105
36" x 36"	312.66	245.20	233.57	55
42" x 42"	512.31	426.71	406.45	80
42" x 42"CT	551.46	462.30	440.33	80
48" x 48"	568.66	473.65	451.16	95
24" Round	212.98	154.60	147.23	25
30" Round	270.74	207.09	197.26	30
36" Round	336.09	266.52	253.84	45
42" Round	515.31	429.40	409.00	65
48" Round	568.49	477.78	455.09	80
54" Round	890.60	770.61	733.98	110
60" Round	955.80	829.88	790.47	140

# Bullnose Bumper Edge



BN - 125

\*Backing sheet add 10%

**Bullnose Bumper  
Edge is available  
in Black**

**BN - 125 Table Top, 1¼" x ½" Bullnose Bumper Edge, laminates available in Vitro standard laminates.**

	1 - 4	5 - 30	31+	Lbs.
24" x 24"	223.35	163.99	156.20	30
24" x 22"WP	223.35	163.99	156.20	30
24" x 24"CT	249.45	187.74	178.81	30
24" x 30"	263.39	200.43	190.89	35
24" x 28"WP	263.39	200.43	190.89	35
30" x 22"WP	263.39	200.43	190.89	35
24" x 42"	329.14	260.19	247.83	40
24" x 42"WP	329.14	260.19	247.83	40
24" x 42"CT	355.16	283.84	270.36	40
24" x 46"WP	345.53	275.10	262.03	45
24" x 48"	345.53	275.10	262.03	45
24" x 48"WP	345.53	275.10	262.03	45
30" x 30"	279.88	215.41	205.19	35
30" x 28"WP	279.88	215.41	205.19	40
30" x 42"	345.53	275.10	262.03	55
30" x 42"WP	345.53	275.10	262.03	55
30" x 46"WP	409.34	333.10	317.29	60
30" x 48"	409.34	333.10	317.29	60
30" x 58"WP	586.09	493.78	470.33	80
30" x 60"	586.09	493.78	470.33	80
30" x 72"	710.16	606.57	577.77	105
36" x 36"	352.82	281.71	268.31	55
42" x 42"	606.05	511.93	487.63	80
42" x 42"CT	645.35	547.61	524.74	80
48" x 48"	672.73	568.24	541.23	95
24" Round	247.02	185.54	176.72	25
30" Round	316.35	248.56	236.76	30
36" Round	394.76	319.84	304.65	45
42" Round	610.80	515.28	490.82	65
48" Round	673.58	573.32	546.07	80
54" Round	1060.02	924.58	880.66	110
60" Round	1138.33	995.81	948.49	140

*Call Factory for pricing on  
72" Round Tops*

# Economy Wood Edge



Eased

EWE - 125

\*Eased edge only

**Economy Wood Edge Table Top**, 1¼" Wood Edge with ⅝" reveal, laminate is flush with top of wood. Corners are eased, mitered. Available in Vitro standard laminates.

	1 - 6	7+	Lbs.
24" x 24"	Call Factory For Pricing		30
24" x 30"	Call Factory For Pricing		35
24" x 42"	Call Factory For Pricing		40
24" x 48"	Call Factory For Pricing		45
30" x 30"	Call Factory For Pricing		35
30" x 42"	Call Factory For Pricing		55
30" x 48"	Call Factory For Pricing		60
30" x 60"	Call Factory For Pricing		80
30" x 72"	Call Factory For Pricing		105
36" x 36"	Call Factory For Pricing		55
42" x 42"	Call Factory For Pricing		80
42" x 42"CT	Call Factory For Pricing		80
48" x 48"	Call Factory For Pricing		95
24" Round	Call Factory For Pricing		25
30" Round	Call Factory For Pricing		30
36" Round	Call Factory For Pricing		45
42" Round	Call Factory For Pricing		65
48" Round	Call Factory For Pricing		80
54" Round	Call Factory For Pricing		110
60" Round	Call Factory For Pricing		140

\*These particular table tops cannot be pre-drilled for table bases

## Standard Wood Finishes



Walnut

Black

Cherry

Dark Mahogany

Mahogany

Natural

\*Finishes are reproduced as accurately as possible, colors may vary from actual product color.

# Deluxe Wood Edge



**Rolled**

DWR - 125



**Waterfall**

DWW - 125



**Bullnose**

DWB - 125

**Deluxe Wood Edge Table Top**, 1¼" Wood Edge with ⅝" reveal, laminate is flush with top of wood. Corners are eased, mitered. Available in Vitro standard laminates.

	1 - 6	7+	Lbs.
24" x 24"	Call Factory For Pricing		30
24" x 30"	Call Factory For Pricing		35
24" x 42"	Call Factory For Pricing		40
24" x 48"	Call Factory For Pricing		45
30" x 30"	Call Factory For Pricing		35
30" x 42"	Call Factory For Pricing		55
30" x 48"	Call Factory For Pricing		60
30" x 60"	Call Factory For Pricing		80
30" x 72"	Call Factory For Pricing		105
36" x 36"	Call Factory For Pricing		55
42" x 42"	Call Factory For Pricing		80
42" x 42"CT	Call Factory For Pricing		80
48" x 48"	Call Factory For Pricing		95
24" Round	Call Factory For Pricing		25
30" Round	Call Factory For Pricing		30
36" Round	Call Factory For Pricing		45
42" Round	Call Factory For Pricing		65
48" Round	Call Factory For Pricing		80
54" Round	Call Factory For Pricing		110
60" Round	Call Factory For Pricing		140

*\*These particular table tops cannot be pre-drilled for table bases*

## Standard Wood Finishes



Walnut

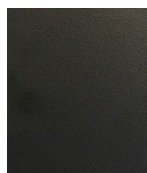

Black

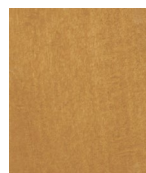

Cherry

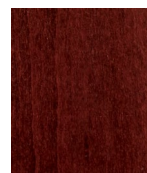

Dark Mahogany

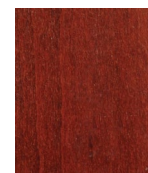

Mahogany



Natural

*\*Finishes are reproduced as accurately as possible, colors may vary from actual product color.*

# Premium Wood Edge



Eased

PWE - 125



Waterfall

PWW - 125

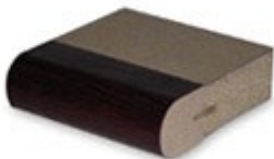

Bullnose

PWB - 125



Rolled

PWR - 125

**Premium Wood Edge Table Top**, 1¼" Wood Edge with 1¼" reveal, laminate edge is flush with top of wood. Layered lap joints (*Inlaid*). Corners are mitered. Available in Vitro standard laminates.

	1 - 6	7+	Lbs.
24" x 24"	Call Factory For Pricing		30
24" x 30"	Call Factory For Pricing		35
24" x 42"	Call Factory For Pricing		40
24" x 48"	Call Factory For Pricing		45
30" x 30"	Call Factory For Pricing		35
30" x 42"	Call Factory For Pricing		55
30" x 48"	Call Factory For Pricing		60
30" x 60"	Call Factory For Pricing		80
30" x 72"	Call Factory For Pricing		105
36" x 36"	Call Factory For Pricing		55
42" x 42"	Call Factory For Pricing		80
42" x 42"CT	Call Factory For Pricing		80
48" x 48"	Call Factory For Pricing		95
24" Round	Call Factory For Pricing		25
30" Round	Call Factory For Pricing		30
36" Round	Call Factory For Pricing		45
42" Round	Call Factory For Pricing		65
48" Round	Call Factory For Pricing		80
54" Round	Call Factory For Pricing		110
60" Round	Call Factory For Pricing		140

\*These particular table tops cannot be pre - drilled for table bases

## Standard Wood Finishes



Walnut

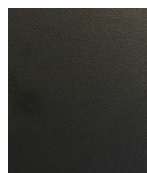

Black

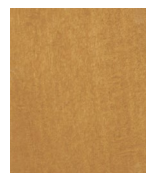

Cherry

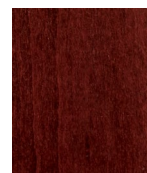

Dark Mahogany

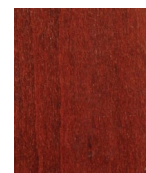

Mahogany



Natural

\*Finishes are reproduced as accurately as possible, colors may vary from actual product color.

# Ultimate Wood Edge



Eased

UWE - 175



Waterfall

UWW - 175



Bullnose

UWB - 175



Rolled

UWR - 175

**Ultimate Wood Edge Table Top**, 1 $\frac{3}{4}$ " Wood Edge with 1 $\frac{3}{4}$ " edge reveal, laminate is flush with top of wood. Corners mitered. Available in Vitro standard laminates.

	1 - 6	7+	Lbs.
24" x 24"	Call Factory For Pricing		30
24" x 30"	Call Factory For Pricing		35
24" x 42"	Call Factory For Pricing		40
24" x 48"	Call Factory For Pricing		45
30" x 30"	Call Factory For Pricing		35
30" x 42"	Call Factory For Pricing		55
30" x 48"	Call Factory For Pricing		60
30" x 60"	Call Factory For Pricing		80
30" x 72"	Call Factory For Pricing		105
36" x 36"	Call Factory For Pricing		55
42" x 42"	Call Factory For Pricing		80
42" x 42"CT	Call Factory For Pricing		80
48" x 48"	Call Factory For Pricing		95
24" Round	Call Factory For Pricing		25
30" Round	Call Factory For Pricing		30
36" Round	Call Factory For Pricing		45
42" Round	Call Factory For Pricing		65
48" Round	Call Factory For Pricing		80
54" Round	Call Factory For Pricing		110
60" Round	Call Factory For Pricing		140

*\*These particular table tops cannot be pre-drilled for table bases*

## Standard Wood Finishes



Walnut

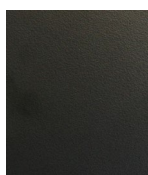

Black



Cherry

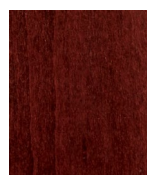

Dark Mahogany

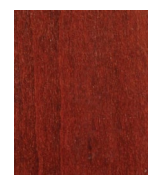

Mahogany



Natural

*\*Finishes are reproduced as accurately as possible, colors may vary from actual product color.*

# Butcher Block & Plank Wood



Eased

SWE - 150 / SWE-125



Bullnose

SWB - 150 / SWB-125



Waterfall

SWW - 150 / SWW-125

\*Also available in Bullnose Bevel,  
Ogee, and Round Edges

**Solid Wood Table Top - Butcher Block (SW - 150)**, 1½" Top thickness.  
**Solid Wood Table Top - Plank (SW - 175)**, 1¼" Top thickness. Both have  
continous lengths of solid Ash or Oak Wood. Corners are standard ⅜" radius.

	Butcher (SW - 150)		Lbs.	Plank (SW - 125)		Lbs.
	1 - 6	7+		1 - 6	7+	
24" x 24"	Call Factory For Pricing		22	Call Factory For Pricing		18
24" x 24" CT	Call Factory For Pricing		22	Call Factory For Pricing		18
24" x 30"	Call Factory For Pricing		27	Call Factory For Pricing		23
24" x 42"	Call Factory For Pricing		38	Call Factory For Pricing		32
24" x 42" CT	Call Factory For Pricing		38	Call Factory For Pricing		38
24" x 48"	Call Factory For Pricing		43	Call Factory For Pricing		36
30" x 30"	Call Factory For Pricing		34	Call Factory For Pricing		28
30" x 42"	Call Factory For Pricing		47	Call Factory For Pricing		39
30" x 48"	Call Factory For Pricing		54	Call Factory For Pricing		45
30" x 60"	Call Factory For Pricing		68	Call Factory For Pricing		56
30" x 72"	Call Factory For Pricing		81	Call Factory For Pricing		68
36" x 36"	Call Factory For Pricing		49	Call Factory For Pricing		41
36" x 36"/51"	Call Factory For Pricing		106	Call Factory For Pricing		88
42" x 42"	Call Factory For Pricing		66	Call Factory For Pricing		65
42" x 42" CT	Call Factory For Pricing		65	Call Factory For Pricing		65
48" x 48"	Call Factory For Pricing		87	Call Factory For Pricing		72
24" Round	Call Factory For Pricing		17	Call Factory For Pricing		16
30" Round	Call Factory For Pricing		27	Call Factory For Pricing		25
36" Round	Call Factory For Pricing		39	Call Factory For Pricing		37
42" Round	Call Factory For Pricing		53	Call Factory For Pricing		50
48" Round	Call Factory For Pricing		69	Call Factory For Pricing		65
54" Round	Call Factory For Pricing		88	Call Factory For Pricing		82
60" Round	Call Factory For Pricing		108	Call Factory For Pricing		102

\* These particular table tops cannot be pre - drilled for table bases

## Standard Wood Finishes

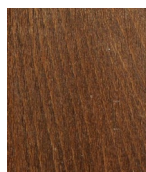

Walnut

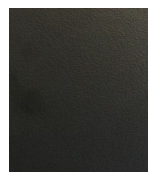

Black

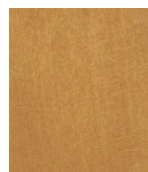

Cherry

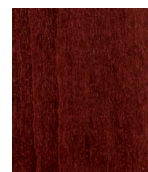

Dark Mahogany

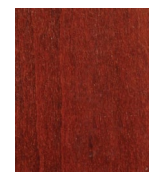

Mahogany

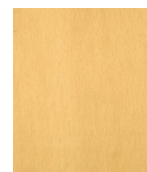

Natural

\*Finishes are reproduced as accurately as possible, colors may vary from actual product color.

# Carbonized Wood Top



Eased - Medium Cherry

CWE - 150



Eased - Natural

CWE - 150



Eased - Walnut

CWE - 150

\*Also available in Bullnose, Waterfall, Bevel, Ogee, and Round Edges

## Carbonized Wood Table Top, 1¼" (CW - 150) or 1¾" (CW - 175)

Top thickness with continuous lengths of solid Ash or Oak Wood. Corners are standard ⅛" radius.

	1¼" (CW - 150)		Lbs.	1¾" (CW - 175)		Lbs.
	1-6	7+		1-6	7+	
24" x 24"	Call Factory For Pricing		18	Call Factory For Pricing		25
24" x 24" CT	Call Factory For Pricing		18	Call Factory For Pricing		25
24" x 30"	Call Factory For Pricing		23	Call Factory For Pricing		32
24" x 42"	Call Factory For Pricing		32	Call Factory For Pricing		44
24" x 42" CT	Call Factory For Pricing		32	Call Factory For Pricing		44
24" x 48"	Call Factory For Pricing		36	Call Factory For Pricing		51
30" x 30"	Call Factory For Pricing		28	Call Factory For Pricing		39
30" x 42"	Call Factory For Pricing		39	Call Factory For Pricing		55
30" x 48"	Call Factory For Pricing		45	Call Factory For Pricing		63
30" x 60"	Call Factory For Pricing		56	Call Factory For Pricing		79
30" x 72"	Call Factory For Pricing		68	Call Factory For Pricing		95
36" x 36"	Call Factory For Pricing		41	Call Factory For Pricing		57
36" x 36"/51"	Call Factory For Pricing		88	Call Factory For Pricing		119
42" x 42"	Call Factory For Pricing		55	Call Factory For Pricing		77
42" x 42" CT	Call Factory For Pricing		55	Call Factory For Pricing		77
48" x 48"	Call Factory For Pricing		72	Call Factory For Pricing		101
24" Round	Call Factory For Pricing		16	Call Factory For Pricing		20
30" Round	Call Factory For Pricing		25	Call Factory For Pricing		32
36" Round	Call Factory For Pricing		37	Call Factory For Pricing		45
42" Round	Call Factory For Pricing		50	Call Factory For Pricing		62
48" Round	Call Factory For Pricing		65	Call Factory For Pricing		81
54" Round	Call Factory For Pricing		82	Call Factory For Pricing		102
60" Round	Call Factory For Pricing		102	Call Factory For Pricing		126

\* These particular table tops cannot be pre-drilled for table bases

# BGA - 125 Table Top



BGA - 125

\* Backing sheet add 10%

GA - 125 also available  
in satin edge.

\* Call Factory for pricing on  
72" Round Tops

\* Call Factory for larger  
sizes up to 48" x 96"

## Racetrack Oval

	1-4	5-30
36" x 48" Oval	726.32	621.15
36" x 60" Oval	1394.43	1228.63

**BGA - 125 Table Top**, 1¼" Bright Grooved Aluminum Edge,  
available in Vitro standard laminates.

	1-4	5-30	31+	Lbs.
24" x 24"	210.63	152.46	145.21	30
24" x 22"WP	214.82	156.22	148.80	30
24" x 24"CT	239.69	178.86	170.37	30
24" x 30"	252.92	190.89	181.84	35
24" x 28"WP	252.92	190.89	181.84	35
30" x 22"WP	252.92	190.89	181.84	35
24" x 42"	315.53	247.81	236.07	40
24" x 42"WP	315.53	247.81	236.07	40
24" x 42"CT	340.42	270.41	257.57	40
24" x 46"WP	331.13	261.96	249.56	45
24" x 48"	331.13	261.96	249.56	45
24" x 48"WP	331.13	261.96	249.56	45
30" x 30"	268.64	205.19	195.45	35
30" x 28"WP	268.64	205.19	195.45	40
30" x 42"	331.13	261.96	249.56	55
30" x 42"WP	331.13	261.96	249.56	55
30" x 46"WP	391.92	317.25	302.18	60
30" x 48"	391.92	317.25	302.18	60
30" x 58"WP	586.09	493.78	470.33	80
30" x 60"	586.09	493.78	470.33	80
30" x 72"	710.16	606.57	577.77	105
36" x 36"	338.07	268.30	255.57	55
42" x 42"	598.64	505.19	481.19	80
42" x 42"CT	618.01	521.58	496.80	80
48" x 48"	664.51	560.77	534.12	95
24" Round	237.36	176.75	168.36	25
30" Round	303.35	236.73	225.47	30
36" Round	377.99	304.61	290.13	45
42" Round	605.27	538.43	522.29	65
48" Round	550.24	546.01	520.08	80
54" Round	1060.02	924.58	880.67	110
60" Round	1138.33	995.81	948.49	140

# BGA-125 Vitro Gloss Cracked Ice



BGA-125 Cracked Ice

\* Backing sheet add 10%

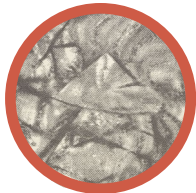

Grey



Red



Yellow

**BGA-125 Table Top**, 1¼" Bright Grooved Aluminum Edge.  
Vitro premium high-gloss Cracked Ice laminate.

	1-4	5-30	31+	Lbs.
24" x 24"	284.49	223.49	212.85	30
24" x 22"WP	284.49	223.49	212.85	30
24" x 24"CT	307.88	244.78	233.14	30
24" x 30"	341.33	275.15	262.11	35
24" x 28"WP	341.33	275.15	262.11	35
30" x 22"WP	341.33	275.15	262.11	35
24" x 42"	442.14	366.82	349.41	40
24" x 42"WP	442.14	366.82	349.41	40
24" x 42"CT	465.61	388.15	369.73	40
24" x 46"WP	477.74	399.18	380.23	45
24" x 48"	477.74	399.18	380.23	45
24" x 48"WP	477.74	399.18	380.23	45
30" x 30"	382.23	312.36	297.51	35
30" x 28"WP	382.23	312.36	297.51	40
30" x 42"	493.40	413.42	393.79	55
30" x 42"WP	493.40	413.42	393.79	55
30" x 46"WP	576.83	489.22	466.00	60
30" x 48"	576.83	489.22	466.00	60
30" x 58"WP	788.13	681.35	649.01	80
30" x 60"	788.13	681.35	649.01	80
30" x 72"	951.83	830.17	790.74	105
36" x 36"	505.16	424.09	403.95	55
42" x 42"	800.90	692.96	660.05	80
42" x 42"CT	836.17	725.02	690.59	80
48" x 48"	907.05	789.45	751.95	95
24" Round	295.87	233.84	222.75	25
30" Round	400.11	314.50	313.00	30
36" Round	523.13	440.44	419.54	45
42" Round	823.96	713.92	679.99	65
48" Round	930.08	810.41	771.89	80
54" Round-seam	1166.63	1025.44	976.73	110
60" Round-seam	1431.27	1266.02	1205.87	140

  

	1-4	5-30
36" x 48" Oval	1037.26	907.84
36" x 60" Oval	1832.52	1630.80

# BGA-125 Vitro Gloss Boomerang



\* Backing sheet add 10%

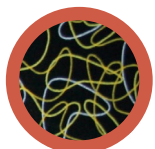

Yellow Ebony



Yellow Glacier

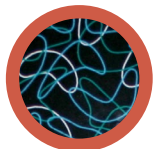

Turquoise Ebony



Turquoise Glacier

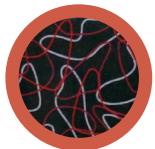

Red Ebony



Red Glacier



Ebony



Glacier

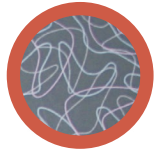

Charcoal

Call Factory for pricing on  
72" Round Tops

	1-4	5-30
36" x 48" Oval	1037.26	907.84
36" x 60" Oval	1832.52	1630.80

**BGA-125 Table Top**, 1/4" Bright Grooved Aluminum Edge.

Vitro premium high-gloss Boomerang laminate.

	1-4	5-30	31+	Lbs.
24" x 24"	284.49	223.49	212.85	30
24" x 22"WP	284.49	223.49	212.85	30
24" x 24"CT	307.88	244.78	233.14	30
24" x 30"	341.33	275.15	262.11	35
24" x 28"WP	341.33	275.15	262.11	35
30" x 22"WP	341.33	275.15	262.11	35
24" x 42"	442.14	366.82	349.41	40
24" x 42"WP	442.14	366.82	349.41	40
24" x 42"CT	465.61	388.15	369.73	40
24" x 46"WP	477.74	399.18	380.23	45
24" x 48"	477.74	399.18	380.23	45
24" x 48"WP	477.74	399.18	380.23	45
30" x 30"	382.23	312.36	297.51	35
30" x 28"WP	382.23	312.36	297.51	40
30" x 42"	493.40	413.42	393.79	55
30" x 42"WP	493.40	413.42	393.79	55
30" x 46"WP	576.83	489.22	466.00	60
30" x 48"	576.83	489.22	466.00	60
30" x 58"WP	788.13	681.35	649.01	80
30" x 60"	788.13	681.35	649.01	80
30" x 72"	951.83	830.17	790.74	105
36" x 36"	505.16	424.09	403.95	55
42" x 42"	800.90	692.96	660.05	80
42" x 42"CT	836.17	725.02	690.59	80
48" x 48"	907.05	789.45	751.95	95
24" Round	295.87	233.84	222.75	25
30" Round	400.11	314.50	313.00	30
36" Round	523.13	440.44	419.54	45
42" Round	823.96	713.92	679.99	65
48" Round	930.08	810.41	771.89	80
54" Round-seam	1166.63	1025.44	976.73	110
60" Round-seam	1431.27	1266.02	1205.87	140

# BGA - 225 Table Top



BGA - 225

\* Backing sheet add 10%

	1 - 4	5 - 30
36" x 48" Oval	929.99	806.38
36" x 60" Oval	1687.35	1494.92

\* Larger size may require crating charges for shipping

**BGA - 225 Table Top**, 2¼" Bright Grooved Aluminum Edge, laminates available in Vitro standard Wilsonart & Formica.

	1 - 4	5 - 30	31+	Lbs.
24" x 24"	277.48	213.23	203.08	30
24" x 22"WP	277.48	213.23	203.08	30
24" x 24"CT	303.56	236.93	225.67	30
24" x 30"	329.52	260.52	248.18	35
24" x 28"WP	329.52	260.52	248.18	35
30" x 22"WP	329.52	260.52	248.18	35
24" x 42"	414.98	338.21	322.15	40
24" x 42"WP	414.98	338.21	322.15	40
24" x 42"CT	441.10	361.94	344.78	40
24" x 46"WP	436.30	357.60	340.60	45
24" x 48"	436.30	357.60	340.60	45
24" x 48"WP	436.30	357.60	340.60	45
30" x 30"	350.98	280.05	266.77	35
30" x 28"WP	350.98	280.05	266.77	40
30" x 42"	436.30	357.60	340.60	55
30" x 42"WP	436.30	357.60	340.60	55
30" x 46"WP	519.24	433.01	412.45	60
30" x 48"	519.24	433.01	412.45	60
30" x 58"WP	749.05	641.92	611.44	80
30" x 60"	749.05	641.92	611.44	80
30" x 72"	910.28	788.46	751.02	105
36" x 36"	445.82	366.25	348.86	55
42" x 42"	775.11	665.63	634.01	80
42" x 42"CT	814.29	701.11	667.92	80
48" x 48"	860.39	738.68	703.73	95
24" Round	308.34	241.24	229.79	25
30" Round	398.42	323.16	307.79	30
36" Round	500.31	415.80	396.06	45
42" Round	779.83	669.87	638.06	65
48" Round	862.81	745.33	709.93	80
54" Round	1365.18	1202.04	1144.94	110
60" Round	1467.03	1294.63	1233.14	140

# BGA - 225 Vitro Gloss Cracked Ice



BGA - 225 Cracked Ice

\* Backing sheet add 10%



Grey



Red



Yellow

**BGA - 225 Table Top, 2¼" Bright Grooved Aluminum Edge.**

Vitro premium high-gloss Cracked Ice laminate.

	1 - 4	5 - 30	31+	Lbs.
24" x 24"	358.14	290.45	276.64	30
24" x 22"WP	358.14	290.45	276.64	30
24" x 24"CT	381.63	311.80	297.00	30
24" x 30"	432.03	357.63	340.66	35
24" x 28"WP	432.03	357.63	340.66	35
30" x 22"WP	432.03	357.63	340.66	35
24" x 42"	563.19	476.87	454.22	40
24" x 42"WP	563.19	476.87	454.22	40
24" x 42"CT	586.70	498.22	474.56	40
24" x 46"WP	609.51	518.93	494.31	45
24" x 48"	609.51	518.93	494.31	45
24" x 48"WP	609.51	518.93	494.31	45
30" x 30"	485.33	406.05	386.78	35
30" x 28"WP	485.33	406.05	386.78	40
30" x 42"	629.87	537.49	511.94	55
30" x 42"WP	629.87	537.49	511.94	55
30" x 46"WP	738.30	636.05	605.84	60
30" x 48"	738.30	636.05	605.84	60
30" x 58"WP	1013.02	885.81	843.72	80
30" x 60"	1013.02	885.81	843.72	80
30" x 72"	1225.79	1079.23	1027.96	105
36" x 36"	645.21	551.42	525.23	55
42" x 42"	1029.68	900.92	858.14	80
42" x 42"CT	1064.90	932.97	888.66	80
48" x 48"	1167.58	1026.28	977.53	95
24" Round	373.06	304.01	289.58	25
30" Round	508.53	427.18	406.91	30
36" Round	668.52	572.62	545.41	45
42" Round	1059.48	928.05	883.96	65
48" Round	1197.49	1053.47	1003.44	80
54" Round-seam	1505.09	1333.13	1269.82	110
60" Round-seam	1849.03	1645.80	1567.61	140

	1 - 4	5 - 30
36" x 48" Oval	1336.96	1180.26
36" x 60" Oval	2136.52	1907.16

# BGA - 225 Vitro Gloss Boomerang

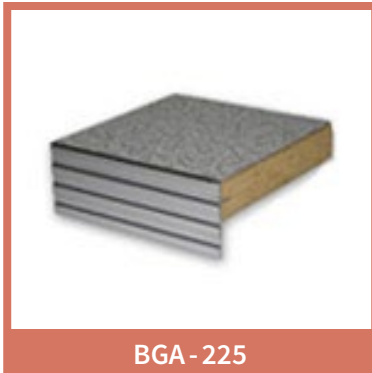

BGA - 225

\* Backing sheet add 10%

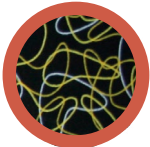

Yellow Ebony



Yellow Glacier

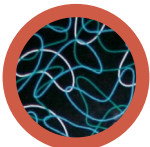

Turquoise Ebony



Turquoise Glacier

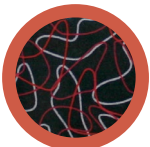

Red Ebony



Red Glacier



Ebony



Glacier



Charcoal

Call Factory for pricing on  
72" Round Tops

	1-4	5-30
36" x 48" Oval	1336.96	1157.12
36" x 60" Oval	2136.52	1869.76

**BGA - 225 Table Top, 2¼" Bright Grooved Aluminum Edge.**

Vitro premium high - gloss Boomerang laminate.

	1-4	5-30	31+	Lbs.
24" x 24"	358.14	290.45	276.64	30
24" x 22"WP	358.14	290.45	276.64	30
24" x 24"CT	381.63	311.80	297.00	30
24" x 30"	432.03	357.63	340.66	35
24" x 28"WP	432.03	357.63	340.66	35
30" x 22"WP	432.03	357.63	340.66	35
24" x 42"	563.19	476.87	454.22	40
24" x 42"WP	563.19	476.87	454.22	40
24" x 42"CT	586.70	498.22	474.56	40
24" x 46"WP	609.51	518.93	494.31	45
24" x 48"	609.51	518.93	494.31	45
24" x 48"WP	609.51	518.93	494.31	45
30" x 30"	485.33	406.05	386.78	35
30" x 28"WP	485.33	406.05	386.78	40
30" x 42"	629.87	537.49	511.94	55
30" x 42"WP	629.87	537.49	511.94	55
30" x 46"WP	738.30	636.05	605.84	60
30" x 48"	738.30	636.05	605.84	60
30" x 58"WP	1013.02	885.81	843.72	80
30" x 60"	1013.02	885.81	843.72	80
30" x 72"	1225.79	1079.23	1027.96	105
36" x 36"	645.21	551.42	525.23	55
42" x 42"	1029.68	900.92	858.14	80
42" x 42"CT	1064.90	932.97	888.66	80
48" x 48"	1167.58	1026.28	977.53	95
24" Round	373.06	304.01	289.58	25
30" Round	508.53	427.18	406.91	30
36" Round	668.52	572.62	545.41	45
42" Round	1059.48	928.05	883.96	65
48" Round	1197.49	1053.47	1003.44	80
54" Round-seam	1505.09	1333.13	1269.82	110
60" Round-seam	1849.03	1645.80	1567.61	140

# SE-125 Table Top



SE-125

\*Backing sheet add 10%

Radius corners add  
10.85 each corner

For table top longevity  
& safety reasons, Vitro  
recommends radius  
corners on all self-edge  
table tops.

Call Factory for pricing on  
72" Round Tops

**SE-125 Table Top**, 1¼" Self Edge, available in Vitro  
standard laminates.

	1-4	5-30	31+	Lbs.
24" x 24"	212.47	153.35	146.04	30
24" x 22"WP	237.37	175.99	167.65	30
24" x 24"CT	295.06	228.43	217.57	30
24" x 30"	249.93	187.39	178.48	35
24" x 28"WP	274.83	210.03	200.08	35
30" x 22"WP	274.83	210.03	200.08	35
24" x 42"	311.35	243.21	231.66	40
24" x 42"WP	336.24	265.87	253.23	40
24" x 42"CT	408.71	331.71	315.96	40
24" x 46"WP	351.59	279.83	266.50	45
24" x 48"	326.77	257.25	244.96	45
24" x 48"WP	351.59	279.83	266.50	45
30" x 30"	265.44	201.45	191.91	35
30" x 28"WP	290.27	224.04	213.41	40
30" x 42"	326.65	257.16	244.93	55
30" x 42"WP	351.59	279.83	266.50	55
30" x 46"WP	411.28	334.05	318.21	60
30" x 48"	386.35	311.41	296.60	60
30" x 58"WP	576.55	484.32	461.31	80
30" x 60"	551.63	461.65	439.73	80
30" x 72"	667.60	567.09	540.15	105
36" x 36"	333.48	263.35	250.85	55
42" x 42"	570.45	478.77	456.03	80
42" x 42"CT	706.73	602.63	574.04	80
48" x 48"	633.48	536.08	510.62	95
24" Round	234.63	173.48	165.24	25
30" Round	299.41	232.38	221.34	30
36" Round	372.73	299.03	284.84	45
42" Round	573.76	481.80	458.91	65
48" Round	633.48	536.08	510.62	80
54" Round	994.35	864.13	823.09	110
60" Round	1068.06	931.16	886.92	140

# SE-200 Table Top



SE - 200

\*Backing sheet add 10%

Radius corners add  
11.07 each corner.

For table top longevity  
& safety reasons, Vitro  
recommends radius  
corners on all self-edge  
table tops.

**SE - 200 Table Top**, 2" Self Edge, available in Vitro standard laminates.

	1 - 4	5 - 30	31+	Lbs.
24" x 24"	277.48	213.23	203.08	30
24" x 22"WP	301.91	235.42	224.27	30
24" x 24"CT	368.83	296.24	282.16	30
24" x 30"	329.52	260.52	248.18	35
24" x 28"WP	353.94	282.70	269.27	35
30" x 22"WP	353.94	282.70	269.27	35
24" x 42"	414.98	338.21	322.15	40
24" x 42"WP	439.34	360.34	343.24	40
24" x 42"CT	526.90	439.94	419.07	40
24" x 46"WP	460.67	379.77	361.73	45
24" x 48"	436.30	357.60	340.60	45
24" x 48"WP	460.67	379.77	361.72	45
30" x 30"	350.98	280.05	266.77	35
30" x 28"WP	375.43	302.28	287.91	40
30" x 42"	436.30	357.60	340.60	55
30" x 42"WP	460.67	379.77	361.72	55
30" x 46"WP	543.62	455.16	433.55	60
30" x 48"	519.24	433.01	412.45	60
30" x 58"WP	773.50	664.15	632.59	80
30" x 60"	749.05	641.92	611.44	80
30" x 72"	910.28	788.46	751.02	105
36" x 36"	445.82	366.25	348.86	55
42" x 42"	775.11	665.63	634.01	80
42" x 42"CT	941.05	816.48	777.68	80
48" x 48"	862.81	745.33	709.93	95
24" Round	308.34	241.24	229.79	25
30" Round	398.42	323.16	307.79	30
36" Round	500.31	415.80	396.06	45
42" Round	779.83	669.87	638.06	65
48" Round	862.81	745.33	709.93	80
54" Round	1365.21	1202.07	1144.98	110
60" Round	1467.03	1294.63	1233.14	140

# Table Bases

*Vitro* carries a wide variety of table bases. The “H” series base and 884/885 legs are a perfect choice for the classic retro look. “A” “B” “C” “D” series bases represent round tubular, flat, rectangular, and steel designs. Painted textured black finish is standard for “A” , “B”, and “D” . Bases come in all paint colors. Upcharge for premium paints is 14.37 and powder chrome finish is 28.71.



# “A” Series Base











“A” series base represents a 2" round tubular design. Painted textured black finish is standard. Must specify other colors. Chrome is optional.

\*Add 18.44 for chrome column (30"H), Add 27.68 for chrome column (42"H)

\*Add 33.15 for 42" high

\*Add 23.43 for wheelchair height

			
A-2x22/2x26			
	<b>1 - 4</b>	<b>5 - 30</b>	<b>31+</b>
	269.47	205.95	196.84
	Add: 65.27 for chrome base bottom Packed Weight: 13 lbs Two bases required per top		
			
A-22x22			
	<b>1 - 4</b>	<b>5 - 30</b>	<b>31+</b>
	273.33	209.46	200.20
	Add: 71.94 for chrome base bottom Packed Weight: 15 lbs Top Capacity: 24" x 24"		
			
A-26x26			
	<b>1 - 4</b>	<b>5 - 30</b>	<b>31+</b>
	279.00	214.61	205.08
	Add: 71.94 for chrome base bottom Packed Weight: 19 lbs Top Capacity: 30" x 30"		
			
A-30x30			
	<b>1 - 4</b>	<b>5 - 30</b>	<b>31+</b>
	284.05	219.21	209.47
	Add: 98.10 for chrome base bottom Packed Weight: 21 lbs Top Capacity: 36" x 36"		
			
A-34x34			
	<b>1 - 4</b>	<b>5 - 30</b>	<b>31+</b>
	289.75	224.35	214.37
	Add: 98.10 for chrome base bottom Packed Weight: 23 lbs Top Capacity: 42" x 42"		
			
A-42x42			
	<b>1 - 4</b>	<b>5 - 30</b>	<b>31+</b>
	300.42	234.08	223.62
	Add: 130.84 for chrome base bottom Packed Weight: 27 lbs Top Capacity: 54" Round		
			
A-22x30			
	<b>1 - 4</b>	<b>5 - 30</b>	<b>31+</b>
	278.93	214.51	205.01
	Add: 98.10 for chrome base bottom Packed Weight: 21 lbs Top Capacity: 24" x 48"		
			
A-26x30			
	<b>1 - 4</b>	<b>5 - 30</b>	<b>31+</b>
	281.67	217.03	207.39
	Add: 98.10 for chrome base bottom Packed Weight: 22 lbs Top Capacity: 30" x 48"		

# "B" Series Base



"B" series base, represents standard textured black column and base bottom.

\*Add 33.15 for 42" high

\*Add 23.43 for wheelchair height

## #10 Glide

### 30" Height

### 42" Height

B-4x22

1 - 4	5 - 30	31+
166.76	113.35	108.50
Packed Weight: 20 lbs      Two bases required per top		

1 - 4	5 - 30	31+
202.53	145.85	141.00
Packed Weight: 20 lbs      Two bases required per top		

B-4x30

1 - 4	5 - 30	31+
196.01	139.92	135.02
Packed Weight: 23 lbs      Two bases required per top		

1 - 4	5 - 30	31+
231.78	172.44	167.55
Packed Weight: 23 lbs      Two bases required per top		

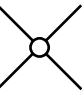
B-22x22

1 - 4	5 - 30	31+
190.25	134.69	129.57
Packed Weight: 22 lbs      Top Capacity: 30" x 30"		

1 - 4	5 - 30	31+
226.01	167.19	162.07
Packed Weight: 22 lbs      Top Capacity: 22" x 22"		

B-30x30

1 - 4	5 - 30	31+
214.54	156.73	151.09
Packed Weight: 30 lbs      Top Capacity: 42" x 42"		

1 - 4	5 - 30	31+
250.30	189.24	183.60
Packed Weight: 30 lbs      Top Capacity: 30" x 30"		

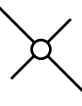
B-22x30

1 - 4	5 - 30	31+
215.72	157.81	152.16
Packed Weight: 26 lbs      Top Capacity: 30" x 48"		

1 - 4	5 - 30	31+
251.47	190.31	184.67
Packed Weight: 26 lbs      Top Capacity: 24" x 30"		

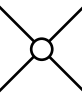
B-36x36

1 - 4	5 - 30	31+
319.59	252.25	244.31
Packed Weight: 34 lbs      Top Capacity: 54" x 54"		

1 - 4	5 - 30	31+
355.36	284.75	276.84
Packed Weight: 34 lbs      Top Capacity: 36 x 36"		

*Available in most paint colors.*

\* Not available in powder chrome, gold, and white.

# "B" Series Base Chrome



"B" series base chrome, represents chrome column with a chrome base bottom.

\*Add 18.44 for chrome column (30"H)

Add 27.68 for chrome column (42"H)

\*Add 23.43 for wheelchair height

## #10 Glide

### 30" Height

### 42" Height

	1 - 4	5 - 30	31+		1 - 4	5 - 30	31+	
	Call Factory For Pricing				Call Factory For Pricing			
B-4x22	Packed Weight: 20 lbs			Two bases required per top	Packed Weight: 20 lbs			Two bases required per top
	Call Factory For Pricing				Call Factory For Pricing			
B-22x22	Packed Weight: 22 lbs			Top Capacity: 30" x 30"	Packed Weight: 22 lbs			Top Capacity: 22" x 22"
	Call Factory For Pricing				Call Factory For Pricing			
B-30x30	Packed Weight: 30 lbs			Top Capacity: 42" x 42"	Packed Weight: 30 lbs			Top Capacity: 30" x 30"
	Call Factory For Pricing				Call Factory For Pricing			
B-22x30	Packed Weight: 26 lbs			Top Capacity: 30" x 48"	Packed Weight: 26 lbs			Top Capacity: 24" x 30"
	Call Factory For Pricing				Call Factory For Pricing			
B-36x36	Packed Weight: 34 lbs			Top Capacity: 54" x 54"	Packed Weight: 34 lbs			Top Capacity: 36" x 36"

*Call factory for availability*





# “C” Series Base



“C” series base represents the “Classic” flat steel design. Textured black bottom with chrome column is standard. Textured black column available at no extra cost.

\*Add 23.43 for wheelchair height per column

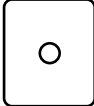
## #10 Glide

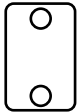
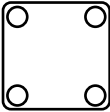
	<b>1 - 4</b>	<b>5 - 30</b>	<b>31+</b>
	287.31	235.19	224.91
<b>C - 6x22</b>	Packed Weight: 30lbs <i>Two bases required per top</i>		
	<b>1 - 4</b>	<b>5 - 30</b>	<b>31+</b>
	284.76	241.82	231.06
<b>C - 18x18</b>	Packed Weight: 40lbs      Top Capacity: 36" x 36"		
	<b>1 - 4</b>	<b>5 - 30</b>	<b>31+</b>
	313.85	264.43	252.66
<b>C - 16x22</b>	Packed Weight: 45lbs      Top Capacity: 30" x 42"		
	<b>1 - 4</b>	<b>5 - 30</b>	<b>31+</b>
	316.20	273.23	260.99
<b>C - 22x22</b>	Packed Weight: 48lbs      Top Capacity: 42" x 42"		
	<b>1 - 4</b>	<b>5 - 30</b>	<b>31+</b>
	467.40	402.13	384.14
<b>C - 18x30</b>	Packed Weight: 50lbs      Top Capacity: 36" x 48"		
	<b>1 - 4</b>	<b>5 - 30</b>	<b>31+</b>
	606.68	546.20	522.34
<b>C - 22x36</b>	Packed Weight: 85lbs      Top Capacity: 42" x 60"      * 2 columns		
	<b>1 - 4</b>	<b>5 - 30</b>	<b>31+</b>
	530.98	488.05	467.81
<b>C - 30x30</b>	Packed Weight: 95lbs      Top Capacity: 48" x 72"      * 4 columns		

*Available in all paint colors.*



# "C" Series Base



"C" series base represents the "Classic" flat steel design. Textured black bottom with chrome column is standard. Textured black column available at no extra cost.

\*Add 23.43 for wheelchair height

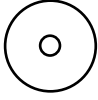
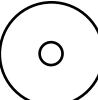
*#10 Glide*

 C-18	<b>1 - 4</b>	<b>5 - 30</b>	<b>31+</b>
	354.84	275.20	262.94
Packed Weight: 35 lbs    Top Capacity: 30" Round			
 C-21	<b>1 - 4</b>	<b>5 - 30</b>	<b>31+</b>
	354.84	275.20	262.94
Packed Weight: 40 lbs    Top Capacity: 36" Round			
 C-24	<b>1 - 4</b>	<b>5 - 30</b>	<b>31+</b>
	490.41	390.87	373.25
Packed Weight: 50 lbs    Top Capacity: 42" Round			

*Available in all paint colors.*



"SC" series base represents the Raised Stamped steel design with a 4" Round Column. Textured black bottom and column

6 Glides

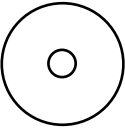
 SC-30	<b>1 - 4</b>	<b>5 - 30</b>	<b>31+</b>
	620.21	524.79	500.55
Packed Weight: 85 lbs    Top Capacity: 60" Round			





# “C” Series Base - Bar Height

42" Height



“C” series base represents the “Classic” flat steel design. Textured black bottom with chrome column is standard. Textured black column available at no extra cost.

## #10 Glide

 C-21-42	1 - 4	5 - 30	31+
	372.93	299.96	286.74
Packed Weight: 55 lbs    Top Capacity: 30" Round			
 C-21-42FR	1 - 4	5 - 30	31+
	547.59	458.76	438.82
Packed Weight: 60 lbs    Top Capacity: 30" Round    Footring			
 C-24-42	1 - 4	5 - 30	31+
	395.94	320.91	306.68
Packed Weight: 65 lbs    Top Capacity: 36" Round			
 C-24-42FR	1 - 4	5 - 30	31+
	581.16	489.29	467.89
Packed Weight: 70 lbs    Top Capacity: 36" Round    Footring			
 SC-30-42	1 - 4	5 - 30	31+
	Call Factory For Pricing		
Packed Weight: 95 lbs    Top Capacity: 42" Round			

# “D” Series Base











“D” series base, represents a 1" x 2" rectangle tubular steel design standard in textured black finish also available in all painted finishes, as well as optional chrome.

\*Add 18.44 for chrome column

\*Add 23.43 for wheelchair height

## #7 Glide

	<b>1 - 4</b> <b>5 - 30</b> <b>31+</b>
	227.73      168.00      160.68
<b>D - 2x22 / 2x26</b>	<b>Add:</b> 69.26 for chrome <b>Packed Weight:</b> 18 lbs <i>Two bases required</i>
	<b>1 - 4</b> <b>5 - 30</b> <b>31+</b>
	231.70      171.62      164.16
<b>D - 22x22</b>	<b>Add:</b> 76.34 for chrome <b>Packed Weight:</b> 20 lbs <b>Top Capacity:</b> 24" x 24"
	<b>1 - 4</b> <b>5 - 30</b> <b>31+</b>
	237.29      176.68      168.99
<b>D - 26x26</b>	<b>Add:</b> 76.34 for chrome <b>Packed Weight:</b> 22 lbs <b>Top Capacity:</b> 30" x 30"
	<b>1 - 4</b> <b>5 - 30</b> <b>31+</b>
	242.59      181.47      173.54
<b>D - 30x30</b>	<b>Add:</b> 104.10 for chrome <b>Packed Weight:</b> 24 lbs <b>Top Capacity:</b> 36" x 36"
	<b>1 - 4</b> <b>5 - 30</b> <b>31+</b>
	248.11      186.54      178.34
<b>D - 34x34</b>	<b>Add:</b> 138.85 for chrome <b>Packed Weight:</b> 26 lbs <b>Top Capacity:</b> 42" x 42"
	<b>1 - 4</b> <b>5 - 30</b> <b>31+</b>
	258.77      196.21      187.56
<b>D - 42x42</b>	<b>Add:</b> 138.85 for chrome <b>Packed Weight:</b> 30 lbs <b>Top Capacity:</b> 54" Round
	<b>1 - 4</b> <b>5 - 30</b> <b>31+</b>
	237.19      176.57      168.85
<b>D - 22x30</b>	<b>Add:</b> 104.10 for chrome <b>Packed Weight:</b> 30 lbs <b>Top Capacity:</b> 24" x 42"
	<b>1 - 4</b> <b>5 - 30</b> <b>31+</b>
	239.92      179.07      171.24
<b>D - 26x30</b>	<b>Add:</b> 104.10 for chrome <b>Packed Weight:</b> 25 lbs <b>Top Capacity:</b> 30" x 48"

# "D" Series Base - Bar Height

42" Height





"D" series base, represents a 1" x 2" rectangle tubular steel design standard in textured black finish also available in all painted finishes, as well as optional chrome.

\* Add 20.29 for chrome column

\* Add 23.42 for wheelchair height

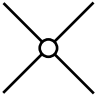
## #7 Glide

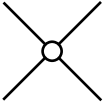
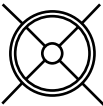
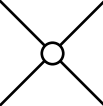
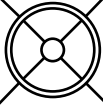
	<table border="1"> <thead> <tr> <th>1 - 4</th> <th>5 - 30</th> <th>31+</th> </tr> </thead> <tbody> <tr> <td>284.81</td> <td>219.11</td> <td>209.70</td> </tr> <tr> <td>Add: 76.34 for chrome</td> <td>Packed Weight: 27 lbs</td> <td>Top Capacity: 24" Round</td> </tr> </tbody> </table>			1 - 4	5 - 30	31+	284.81	219.11	209.70	Add: 76.34 for chrome	Packed Weight: 27 lbs	Top Capacity: 24" Round	
	1 - 4	5 - 30	31+										
284.81	219.11	209.70											
Add: 76.34 for chrome	Packed Weight: 27 lbs	Top Capacity: 24" Round											
D - 22x22 - 42													
	<table border="1"> <thead> <tr> <th>1 - 4</th> <th>5 - 30</th> <th>31+</th> </tr> </thead> <tbody> <tr> <td>463.66</td> <td>381.70</td> <td>365.45</td> </tr> <tr> <td>Add: 76.34 for chrome</td> <td>Packed Weight: 30 lbs</td> <td>Top Capacity: 24" Round</td> </tr> </tbody> </table>			1 - 4	5 - 30	31+	463.66	381.70	365.45	Add: 76.34 for chrome	Packed Weight: 30 lbs	Top Capacity: 24" Round	*Footring
	1 - 4	5 - 30	31+										
463.66	381.70	365.45											
Add: 76.34 for chrome	Packed Weight: 30 lbs	Top Capacity: 24" Round											
D - 22x22 - 42FR													
	<table border="1"> <thead> <tr> <th>1 - 4</th> <th>5 - 30</th> <th>31+</th> </tr> </thead> <tbody> <tr> <td>297.93</td> <td>231.04</td> <td>221.09</td> </tr> <tr> <td>Add: 76.34 for chrome</td> <td>Packed Weight: 32 lbs</td> <td>Top Capacity: 30"</td> </tr> </tbody> </table>			1 - 4	5 - 30	31+	297.93	231.04	221.09	Add: 76.34 for chrome	Packed Weight: 32 lbs	Top Capacity: 30"	
	1 - 4	5 - 30	31+										
297.93	231.04	221.09											
Add: 76.34 for chrome	Packed Weight: 32 lbs	Top Capacity: 30"											
D - 30x30 - 42													
	<table border="1"> <thead> <tr> <th>1 - 4</th> <th>5 - 30</th> <th>31+</th> </tr> </thead> <tbody> <tr> <td>549.01</td> <td>459.30</td> <td>439.36</td> </tr> <tr> <td>Add: 104.10 for chrome</td> <td>Packed Weight: 35 lbs</td> <td>Top Capacity: 30"</td> </tr> </tbody> </table>			1 - 4	5 - 30	31+	549.01	459.30	439.36	Add: 104.10 for chrome	Packed Weight: 35 lbs	Top Capacity: 30"	*Footring
	1 - 4	5 - 30	31+										
549.01	459.30	439.36											
Add: 104.10 for chrome	Packed Weight: 35 lbs	Top Capacity: 30"											
D - 30x30 - 42FR													
	<table border="1"> <thead> <tr> <th>1 - 4</th> <th>5 - 30</th> <th>31+</th> </tr> </thead> <tbody> <tr> <td>301.59</td> <td>234.35</td> <td>224.24</td> </tr> <tr> <td>Add: 138.85 for chrome</td> <td>Packed Weight: 34 lbs</td> <td>Top Capacity: 36" Round</td> </tr> </tbody> </table>			1 - 4	5 - 30	31+	301.59	234.35	224.24	Add: 138.85 for chrome	Packed Weight: 34 lbs	Top Capacity: 36" Round	
	1 - 4	5 - 30	31+										
301.59	234.35	224.24											
Add: 138.85 for chrome	Packed Weight: 34 lbs	Top Capacity: 36" Round											
D - 34x34 - 42													
	<table border="1"> <thead> <tr> <th>1 - 4</th> <th>5 - 30</th> <th>31+</th> </tr> </thead> <tbody> <tr> <td>564.21</td> <td>473.11</td> <td>452.54</td> </tr> <tr> <td>Add: 138.85 for chrome</td> <td>Packed Weight: 36 lbs</td> <td>Top Capacity: 36" Round</td> </tr> </tbody> </table>			1 - 4	5 - 30	31+	564.21	473.11	452.54	Add: 138.85 for chrome	Packed Weight: 36 lbs	Top Capacity: 36" Round	*Footring
	1 - 4	5 - 30	31+										
564.21	473.11	452.54											
Add: 138.85 for chrome	Packed Weight: 36 lbs	Top Capacity: 36" Round											
D - 34x34 - 42FR													

# Flip - Top Table

## Not Sold Separately



**The Flip - Top Booth & Table Attachment System** was invented for 2 purposes, cleanliness and an economical way to suspend a table top without the expense of special construction required within the walls of the restaurant. Standard finish is satin black powder coat

### Model FT - 44:

accommodates 44", as well as 48"L booths

549.49 Any qty. Maximum Table Width: 30"

### Model FT - 60:

accommodates booths up to 60"L

605.22 Any qty. Maximum Table Width: 30"

### Model FT - 30:

accommodates both 24" & 30"L deuce booths. This model offers the cantilever effect only, but does not flip up.

509.71 Any qty. Maximum Table Width: 30"



**Special Note:** When ordering this product, please specify the booths and table tops that are to accompany this purchase. Also, please be aware that the table tops will not be pre - drilled, in order for you or your customer to adjust the distance the top will be from the wall. We recommend the top to be approximately 1/4" from the wall.

**The Flip - Top and booth must be ordered together.**

# “F” Series Cantilever

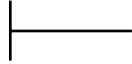

The “F” series cantilever style base utilizes 2" square heavy wall 14 gauge construction with angle support. Black painted finish.

 F-21-WL	<b>1 - 4</b>	<b>5 - 30</b>	<b>31+</b>
	227.60	167.07	159.14
	Packed Weight: 16 lbs      Top Capacity: 24" - 30"		
 F-29-WL	<b>1 - 4</b>	<b>5 - 30</b>	<b>31+</b>
	239.24	177.69	169.26
	Packed Weight: 18 lbs      Top Capacity: 36" - 48"		
 F-47-WL	<b>1 - 4</b>	<b>5 - 30</b>	<b>31+</b>
	254.61	191.66	182.55
	Packed Weight: 25 lbs      Top Capacity: 54" - 60"		

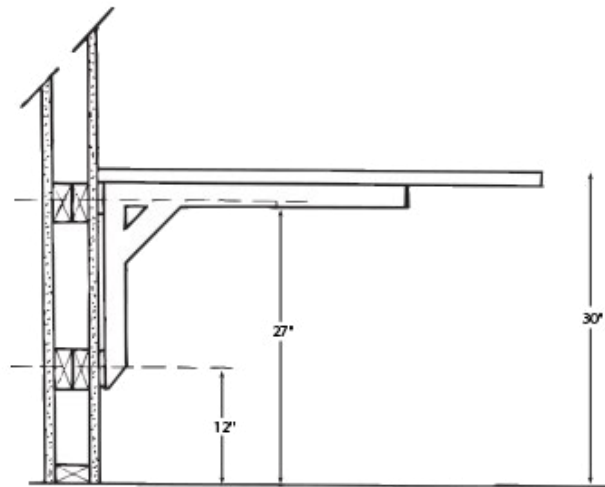

*We recommend wall blocking at 12" and 27"  
to secure the cantilever.*

# “G” Series Cantilever



The “G” series cantilever, utilizes 2" square heavy wall construction and includes table mounting bracket. Black painted finish.

*Painted*

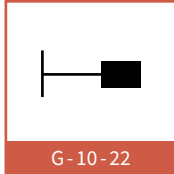

	1 - 4	5 - 30	31+
	144.36	92.20	87.84
Packed Weight: 10 lbs		Top Capacity: 24" - 30"	

*Painted*

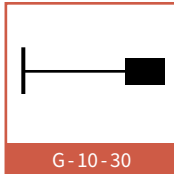

	1 - 4	5 - 30	31+
	157.29	103.95	99.03
Packed Weight: 12 lbs		Top Capacity: 36" - 54"	

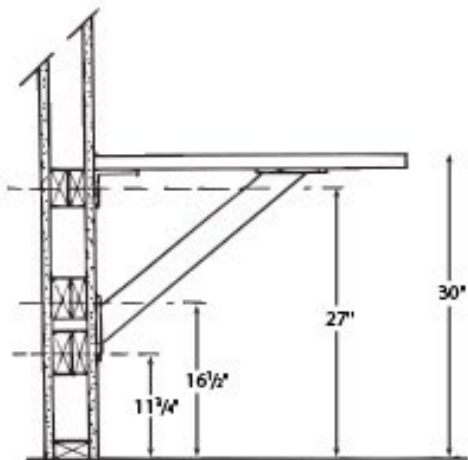

**G-10-22**

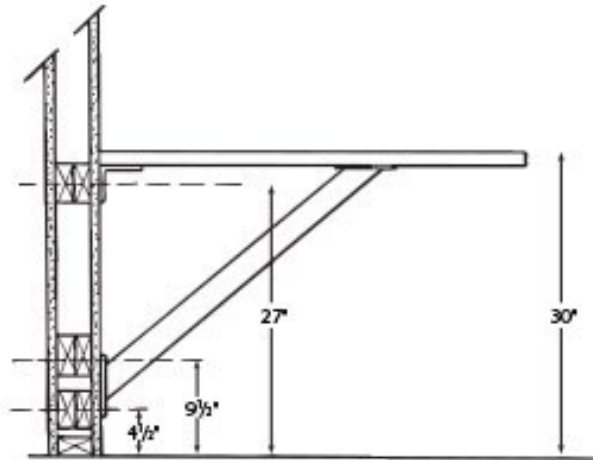

**G-10-30**

*Angle Bracket size: 2" x 2" x 18"*

# “H” Series & 1800 Series Bases



The “H” series fountain style base is a bolt down design utilizing a 3½" column diameter. Painted or standard chrome is the same price.

\*10" x 10" Table Spider, see page 103 for floor attachments



The “H” series fountain style base is a bolt down design utilizing a 3½" column diameter.

\*Teardrop standard colors are red and black.  
\*Standard in Chrome.

\*Shown w/ optional grooved column

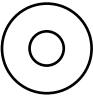
	<b>1 - 4</b>	<b>5 - 30</b>	<b>31+</b>
	306.71	239.02	228.46
	<b>Packed Weight:</b> 14 lbs	<b>Top Capacity:</b> 30" x 42"	<b>*Table Height</b>
H - 28			

	<b>1 - 4</b>	<b>5 - 30</b>	<b>31+</b>
	396.40	318.59	304.27
	<b>Packed Weight:</b> 14 lbs	<b>Top Capacity:</b> 30" x 42"	<b>*Table Height</b>
H - 28 - TD			

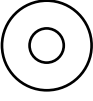

	<b>1 - 4</b>	<b>5 - 30</b>	<b>31+</b>
	387.87	312.76	298.95
	<b>Packed Weight:</b> 20 lbs	<b>Top Capacity:</b> 30" x 30"	<b>*42" Bar Height</b>
H - 40			

	<b>1 - 4</b>	<b>5 - 30</b>	<b>31+</b>
	481.65	396.06	378.35
	<b>Packed Weight:</b> 20 lbs	<b>Top Capacity:</b> 30" x 30"	<b>*42" Bar Height</b>
H - 40 - TD			



“1800” series fountain style base, is a bolt-down design utilizing a 3" square column. Painted only.

\*Type B & C attachments only  
\*10" x 10" table spider

Table Height		<b>1 - 4</b>	<b>5 - 30</b>	<b>31+</b>	
		347.27	276.68	266.33	
		<b>30" Table Height Base</b>	<b>Packed Weight:</b> 27 lbs	<b>Top Capacity:</b> 30 x 42"	
Bar Height		<b>1 - 4</b>	<b>5 - 30</b>	<b>31+</b>	
		421.28	343.91	330.37	
		<b>42" Bar Height Base</b>	<b>Packed Weight:</b> 40 lbs	<b>Top Capacity:</b> 30"	
		1800 - TB - 28			
		1800 - TB - 40			

# PL-1 & 884/885 Legs



PL-1 is a 1", 16 gauge steel pin leg with a standard satin black finish.

\*#7 Adjustable Glide w/ Nylon Bottom

<b>PL-1 singles</b>		
1 - 4	5 - 30	31+
119.63	75.65	71.86
30" Table Height Base	Packed Weight: 10 lbs	Dimensions: 28¾"H



Available in paint

**884 set of 4** Classic Table Legs, 16 gauge, 1½" diameter tubular steel, chrome finish

1 - 4	5 - 30	31+
388.92	315.30	302.12
<b>884 singles</b> Single leg with wall angle bracket		#17 Glide
1 - 4	5 - 30	31+
181.85	127.05	121.45
Add: 58.37 for pre-drill	Packed Weight: 12 lbs	Dimensions: 28¾"H



Available in paint

**885 set of 4** Classic Table Legs, 16 gauge, 1" diameter tubular steel, chrome finish

1 - 4	5 - 30	31+
388.92	315.30	302.12
<b>885 singles</b> Single leg with wall angle bracket		#16 Glide
1 - 4	5 - 30	31+
181.85	127.05	121.45
Add: 58.37 for pre-drill	Packed Weight: 12 lbs	Dimensions: 28¾"H



# ACCESSORIES



**Hall Costumer - Chrome only with 15" round black plate steel base**

331.38

Weight: 25 lbs  
 Dimensions: 60"H  
 Replacement Hooks: 35.42

Hall Costumer



**Booth Costumer - Chrome only**

232.00

#56 two hook style

278.49

#57 three hook style

Weight: 7 lbs  
 Dimensions: 60"H  
 Replacement Hooks: 35.42

Booth Costumer



**Custom Etched Acrylic Gallery**

Call factory for pricing

\*Pricing varies based on design  
 \*Gallery posts standard in powder chrome



**Acrylic Booth Divider**

**Features**  
 12", 18", or 24" Height  
 44", 48", or 60" Booth Length  
 Clear Plexiglass  
 Easy Install Slot

	12" H	18" H	24" H
44" Booth Width	312.06	394.02	457.06
48" Booth Width	312.06	394.02	457.06
60" Booth Width	394.02	488.58	551.65

**Optional:**  
 Custom Acrylic Glass Etching (Call Factory for Pricing)  
 Frosted Glass Available (Call Factory for Pricing)  
 Custom Lengths Available (Call Factory for Pricing)  
 \*Subject to Local Health Department Regulations

# SEATING GUIDELINES

## General guides for space planning and determining furniture needs

### Space Planning:

In preliminary space planning, the "Rule of Thumb" for determining the area requirements for a restaurant is: Dining Room: 60% of total area. Kitchen, Cooking, Storage, Preparation, etc.: 40% of total area.

When originating space requirements, anticipate that Banquet seating may use as little as 10 square feet per person. A good average for restaurants or coffee shops with general menus is about 12 square feet per person. This will provide for traffic aisles, wait stations, etc.

**Example:** A 200 seat restaurant will require 2,400 square feet of dining area. Since this would be 60% of the total area, the total area would be 4000 square feet.

When the area available has already been established (i.e. an existing building being remodeled as a restaurant), the "Rule of Thumb" is used as follows.

**Example:** A space of 2800 square feet is available. 60% **Dining Area:** 1680 square feet (140 seats); 40% **Kitchen Area:** 1120 square feet. Details will be determined after

floor plans are prepared and owner's ideas are considered and incorporated into the plans. Suggested square feet per person for different restaurant types:

- Commercial Cafe:** 16 - 18 square feet
- Industrial Cafe:** 12 - 15 square feet
- Counter Service:** 18 - 20 square feet
- Table Service (minimum):** 11 - 14 square feet
- Table Service, Hotel/Club:** 15 - 18 square feet
- Banquet (minimum):** 10 - 11 square feet

The traffic path between occupied chairs would be at least 18 inches wide. Leave 4 - 5 feet between tables (This figure includes chair space). To determine area for wait stations: 1 small station (6 - 10 square feet) per 20 diners. 1 large central station (25 - 40 square feet) per 60 diners. In determining the length for a bar, allow 1'8" - 1'10" per person (standup) or 2' per bar stool.

### Furniture Guidelines:

- Table Height:** 29" - 30" **Bar Height:** 42" - 45"
- Seat Height:** 17" - 18" **Bar Stool Height:** 28" - 30"

### Bar Dimensions

- A. Outer bar edge to wall.....76" - 84"
- B. Outer bar edge back wall.....82" - 104"
- C. Outer bar edge to drinking shelf.....66" - 72"
- D. Outer bar edge to equipment edge.....23" - 28"
- E. Behind bar traffic area.....30" - 36"
- F. Back bar depth.....24" - 30"
- G. Drinking shelf depth.....10" - 12"
- H. Drinking shelf customer area.....18"
- J. Customer traffic area..... 30"
- K. Bar seating area.....18" - 24"
- L. Bar depth.....18" - 24"
- M. Footstep depth.....6" - 9"
- N. Footstep height.....7" - 9"
- O. Room divider screen (high) .....76"
- P. Room divider screen (low) .....55"
- Q. Drinking shelf height .....42" - 45"
- R. Top of barstool to bottom of bar.....11" - 12"
- S. Depth of behind-bar equipment.....22" - 26"
- T. Behind-bar equipment height.....30"
- U. Bar height.....42" - 45"
- V. Back bar height.....36" - 42"
- W. Back wall shelf height.....60" - 69"

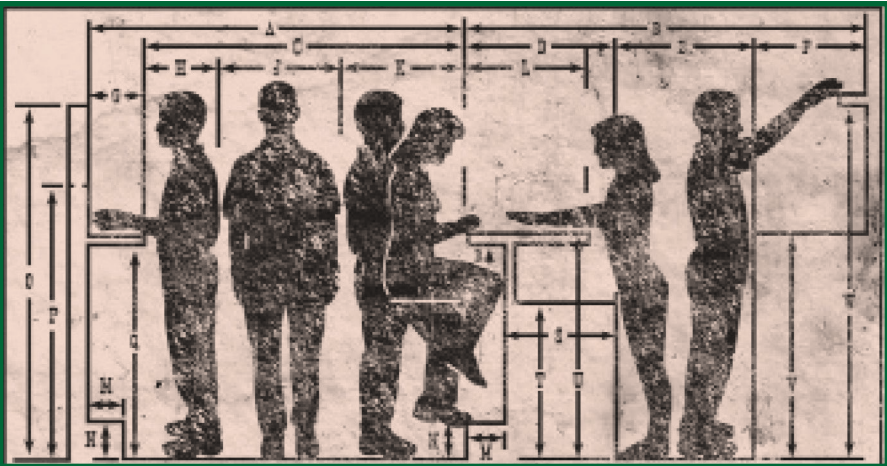

# SEATING GUIDELINES

## FIXED SEATING DIMENSIONS

### Bar Counter Dimensions

- A. Customer seating area.....12" - 18"
- B. Counter depth.....18" - 24"
- C. Service traffic area.....36"
- D. Seat height.....30" - 31"
- E. Footstep height.....12"
- F. Depth of counter underside.....10"
- G. Top of seat to underside of counter..11" - 12"
- H. Counter height.....42"
- J. Back service counter height.....36"

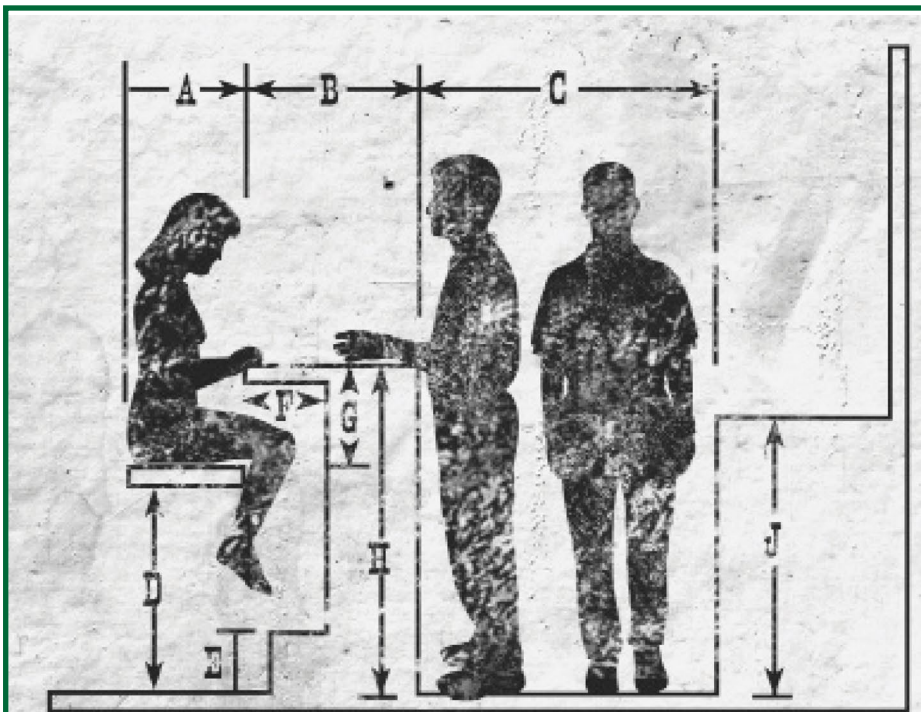

### Booth Dimensions

- A. Total booth width.....64" - 74"
- B. Seat back depth.....3" - 6"
- C. Seat back-to-table edge clearance.....16"
- D. Table width.....24" - 42"
- E. Table edge to back of seat cushion... 19" - 22"
- F. Table top height.....29" - 30"
- G. Top of seat to underside of counter..16" - 18"

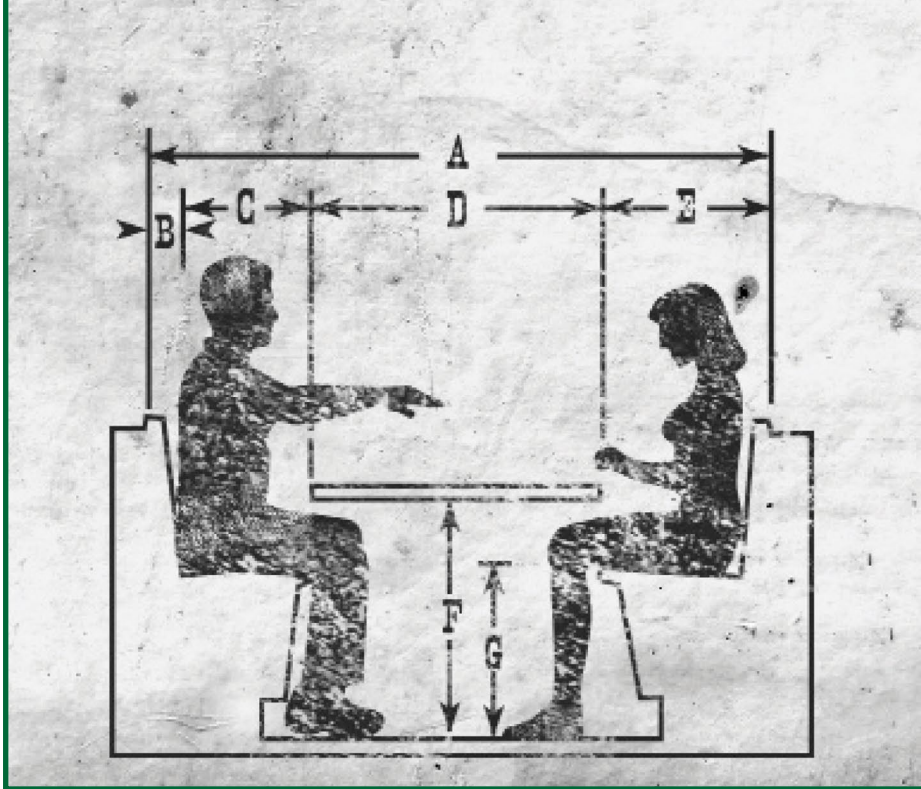

# ADA GUIDELINES

## TABLE SEATING DIMENSIONS

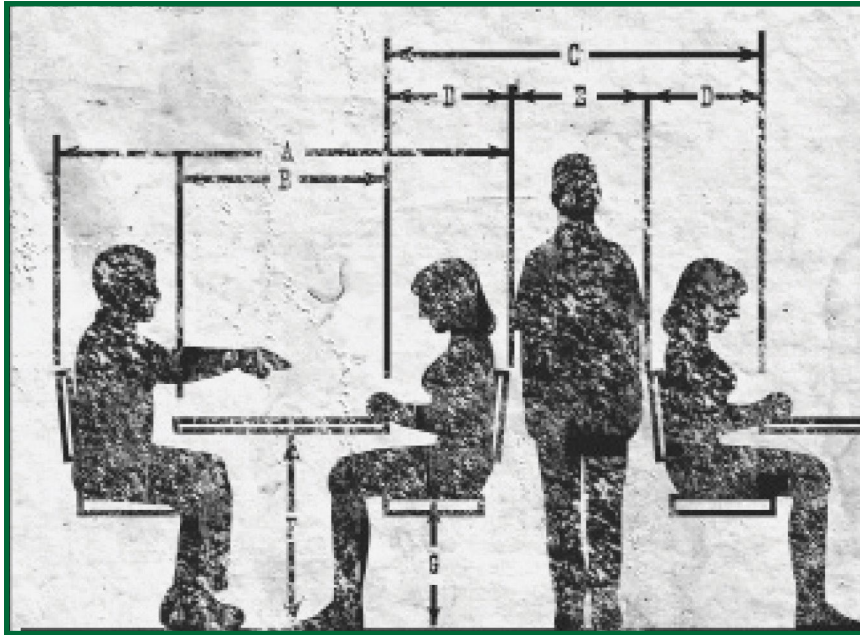

### Table Dimensions

A. Total area required for table.....	60" - 90"
B. Table top width.....	24" - 42"
C. Customer traffic & seating area.....	54" - 72"
D. Customer seating area.....	18" - 24"
E. Traffic area.....	18" - 24"
F. Table top height.....	29" - 30"
G. Seat height.....	16" - 18"

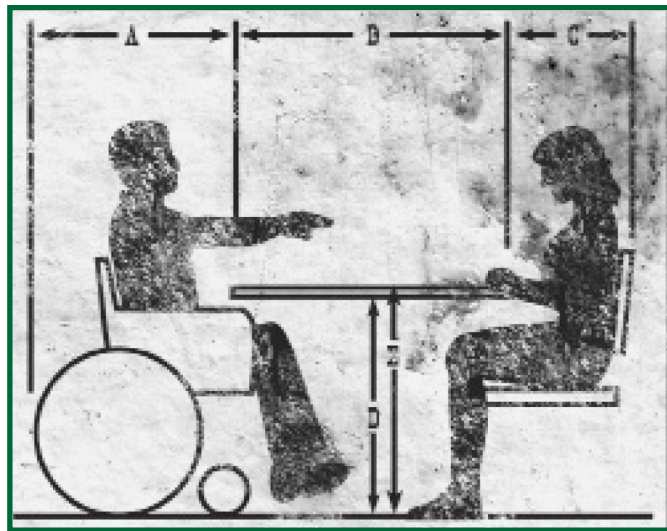

### Wheelchair Requirements

A. Wheelchair seating area.....	30"
B. Table top width.....	24" - 42"
C. Customer seating area.....	18" - 24"
D. Distance to underside of table.....	30"
E. Table top height.....	31"